

*Wei's - l.e.d*<sup>®</sup>

# *2023 Catalog*

**Wei's International Trading Corp**

**718-815-5600**

***weisled@msn.com***

## 3 -COLOR IN 1 TRACK LIGHTING



Item No:

**WG532B & WG532W**

Wattage:**20W** Black & White

CCT:3000K/4000K/5000K

Item No:

**WG 531B & WG 531W**

Wattage:**10W** Black & White

CCT:3000K/4000K/5000K

■ BLACK

□ WHITE

❖ *3CCT changeable : 3000k /4000k /5000k*

❖ *38 ° Angle*

❖ *Dimmable !*

❖ *CRI > 90*

❖ *Input:*

***120V / 50-60 Hz***

❖ *Chip Brand:*

***Bridgelux LED***

❖ *Warranty:*

***3 Years***

New Item of 2021



### 3 COLOR TEMP. CCT



Item No.

#### WG 312B & WG 312W

12W Black & White

Size: L 4.75" x W 2.4" x H 6.3"

#### WG 325B & WG 325W

25W Black & White

Size: L 5.1" x W 3.15" x H 7.1"

■ BLACK

□ WHITE

❖ *3CCT changeable : 3000k /4000k /5000k*

❖ *38 ° Angle*

❖ *Dimmable !*

❖ *CRI > 80*

❖ *Input:*

❖ *Chip Brand:*

❖ *Warranty:*

*120V / 50-60 Hz*

*Bridgelux LED*

*4 Year*

*Wei's - l.e.d*

# 5CCT Changeable

## LED TRACK LIGHT



■ BLACK

□ WHITE

❖ *5 CCT changeable*

❖ *38° Angle*

❖ *Dimmable*

❖ *CRI > 90*

❖ *1000 Lumens*

❖ *Input: 120V / 50-60 Hz*

❖ *Warranty: 30000 hours*

**5CCT changeable:**  
2000K/3000K/4000K  
/5000K/6000K

*Item No.*

***WG 551B & WG 551W***

*10W Black & White*

***Size: 2.95" x 2.36" x 5.1"***

# GU10 TRACK LIGHT



■ BLACK

□ WHITE

❖ Item No. **WG 85B**

❖ Watt: **GU10/ Max 50W**

❖ Voltage: **120V / 50-60 Hz**

❖ Item No. **WG 85W**

❖ Watt: **GU10/ Max 50W**

❖ Voltage: **120V / 50-60 Hz**

Measurement: "mm"

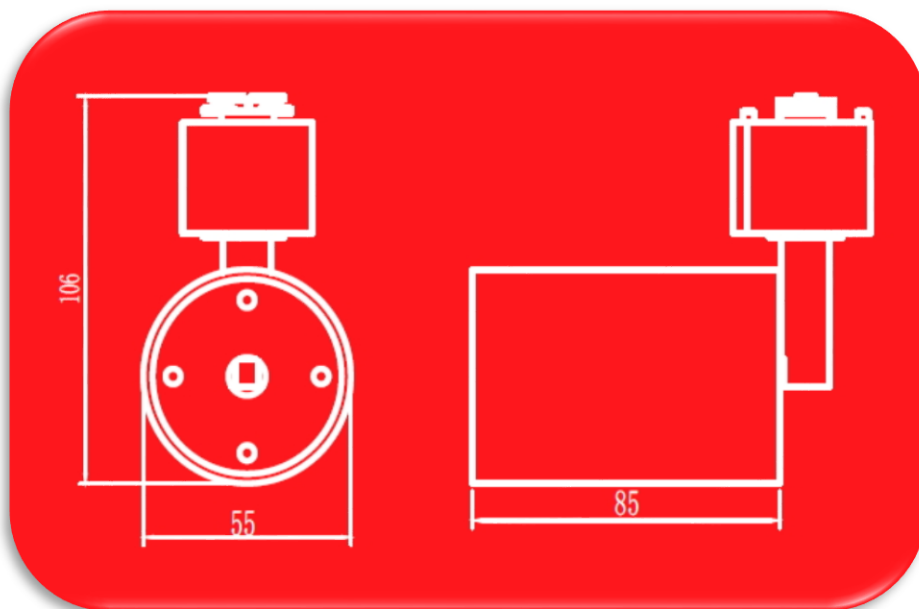

Not include GU10 Light Blub

# LED TRACK LIGHT



- BLACK □WHITE
- ❖24° Angle
- ❖come w/ 38° lens
- ❖Lums: 789

**WG 105B**  
**WG 105W**  
 10W 5000K



- BLACK □WHITE
- ❖38° Angle
- ❖come w/ 24° lens
- ❖Lums: 1315

**WG 155B**  
**WG 155W**  
 15W 5000K

AC 120V / 24° & 38°  
 BEAM / DIMMABLE



- BLACK □WHITE
- ❖38° Angle
- ❖come w/ 24° lens
- ❖Lums: 3295

**WG 353W**  
 35W 3000K  
**WG 355B**  
**WG 355W**  
 35W 5000K



# LED TRACK LIGHT



■ BLACK

□ WHITE

- ❖ *36° Angle*
- ❖ *Dimmable*
- ❖ *CRI > 80*
- ❖ *Light Efficiency: 80 Lums/W*
- ❖ *Track Head: Halo*
- ❖ *Input: 120V / 50-60 Hz*
- ❖ *Chip Brand: Philips*
- ❖ *Warranty: 3 years*

Exchange Lens  
15° -25°  
Angle



WG 012 /12W  
WG 025 /25W

## Item No.

**WG 1123W**

12W 3000K

**WG 1125B & WG 1125W**

12W 5000K

**Size: 6" x 2 1/2" x 6 1/4"**

**WG 1253W**

25W 3000K

**WG 1255B & WG 1255W**

25W 5000K

**Size: 7 1/4" x 3 1/8" x 7"**

# 5 Color Temp. CCT



## WR 4500

4" 10W CCT

2700K/3000K/3500K/4000K/5000K

## WR 6500

6" 15W CCT

2700K/3000K/3500K/4000K/5000K

- ◆ *5 Year Warranty !*
- ◆ *10w Replace 75w & 15w Replace 100w !*
- ◆ *Ultra Thin 1.1 inch Height Only !*
- ◆ *2700K-3000K-3500K-4000K-5000K Changeable*



# COB 110V LED STRIP



**ETL approve**

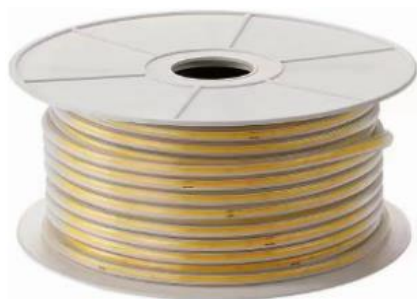

## WS 0036

### **3000K COB LED Strip**

- 90-130V Strip light
- IP65 Waterproof
- 10.5 W/M
- 288 Led Chips/M
- 880 Lumens
- 1.63 Ft./Cut
- 50M=165 Ft./roll
- 8mm PVC
- Temp: -15°C~45°C

## WS 0037

### **6000K COB LED Strip**

- 90-130V Strip light
- IP65 Waterproof
- 10.5 W/M
- 288 Led Chips/M
- 880 Lumens
- 1.63 Ft./Cut
- 50M=165 Ft./roll
- 8mm PVC
- Temp: -15°C~45°C

## **ACCESSORIES**

**\*Power Cord\***

**Item # WS0138C**



**\*U Holder, 8 ft./ ea\***

**Item # WS0132C**

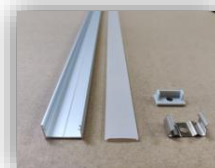

**\*Clip for hold Strip\***

**Item # WS0135**



**\*End Cap for 110V Strip\***

**Item # WS0136**



# 110V 5050 RGB LED STRIP

## WS 0030

165 ft./ Roll



- 110v RGB Striplight
- < 9W/ 3.3 Ft.
- 60 led Chips / Meter
- 14-16Lm. per LED Chip

## WS 0035

330 ft./ Roll

- 1 meter/cut
- 15mm Wide
- Temp: -30°c-45°c
- 100-130V AC IP67

## WS 0156

## WS 0155



- 110v RGB IR Controller 165ft.
- Input: 100-130V
- Current: 3\*3A
- Power: 750W
- Control 160 Ft.
- 24 Key remote controller

- 110v RGB RF Controller 165ft.
- Input: 100-130V
- Current: 3\*3A
- Power: 800W
- Control 160 Ft.
- 24 Key remote controller



## ACCESSORIES



### Item # WS0137

- \* 9" Jump Feet
- \* Use from Power to Strip Only



### Item # WS0138

- \* Power Cord

# 110V 5050 Single Color LED STRIP

**WS 0034 (3000K) & WS 0033 (6000K)**

*165 ft./ Roll*



- 165 ft./ Roll
- 9W / 3.3 Ft.
- 60 led Chips / Meter
- 20-22Lm per LED Chip
- 1 meter/cut
- 15mm Wide
- Temp: -30°C-45°C
- 100-130V AC IP67

## ACCESSORIES



**Item # WS0137S**

\*Middle Jump feet from Strip to Strip, 12" Length

## ACCESSORIES

**Item # WS0138S**

**Power Cord**

# U Holder

## Use For 12V & 110V Strips

### Item # WS 0132B

- ❖ 1 Meter long = 3.3 Ft.
- ❖ Aluminum Base & Frost Cover

### Item # WS 0132C

- ❖ 8 ft. long
- ❖ Aluminum Base & Frost/Clear Cover
- ❖ 8.5 mm deep

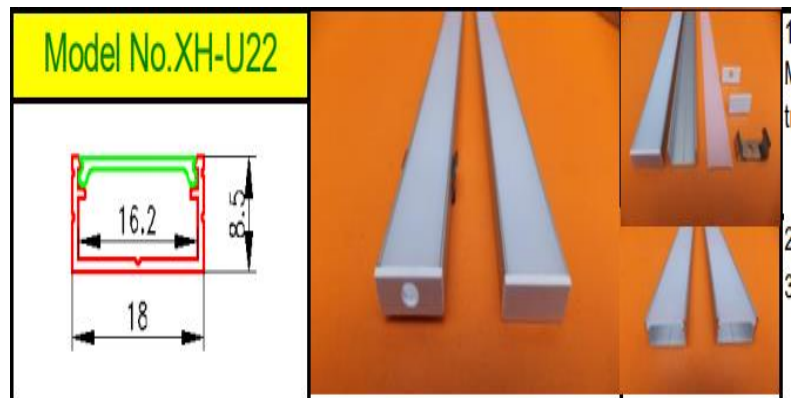

### Item # WS 0132D

- ❖ 8 ft. long
- ❖ Aluminum Base & Frost/Clear Cover
- ❖ 13 mm deep

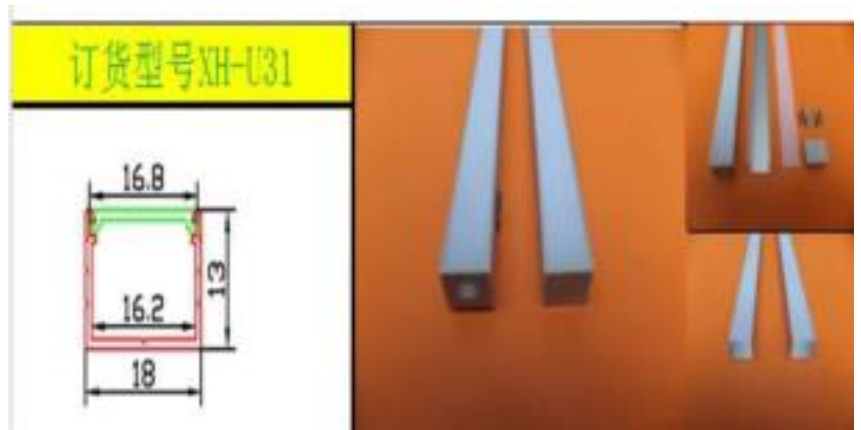

# Instruction for 12v RGB Strip

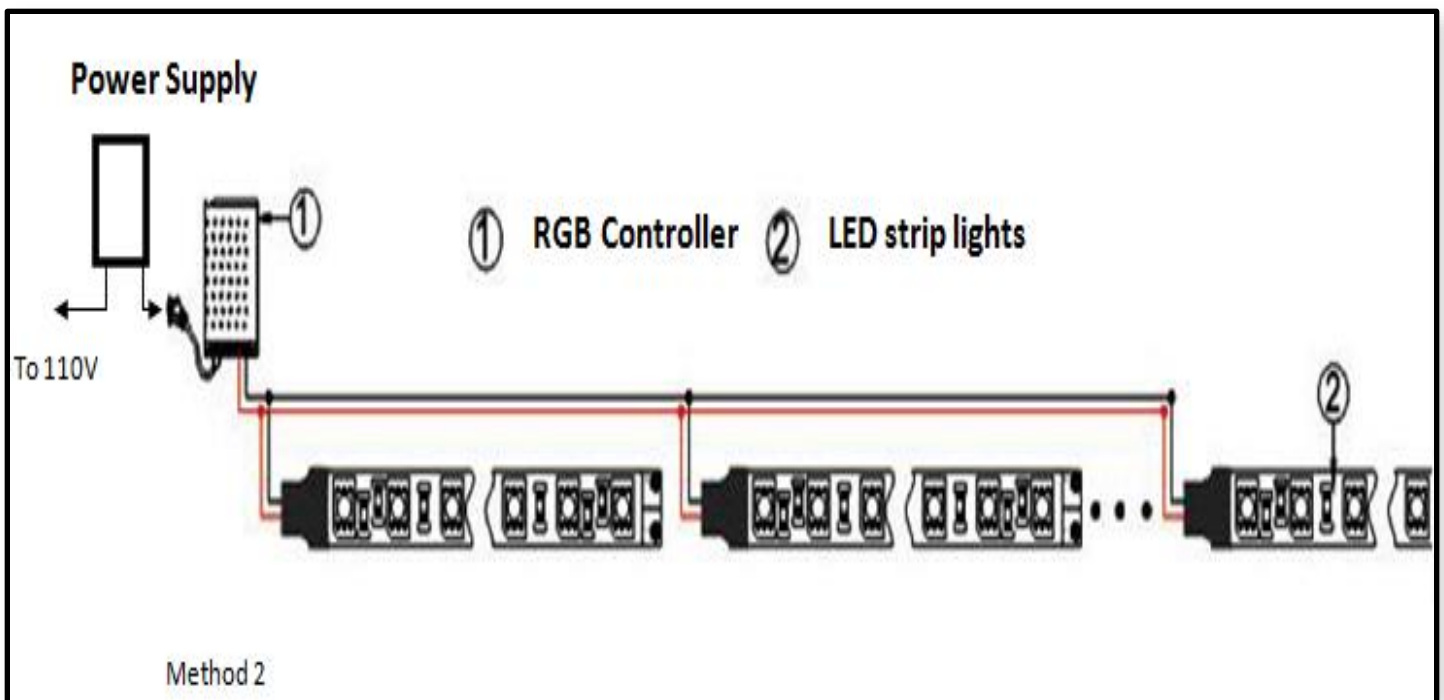
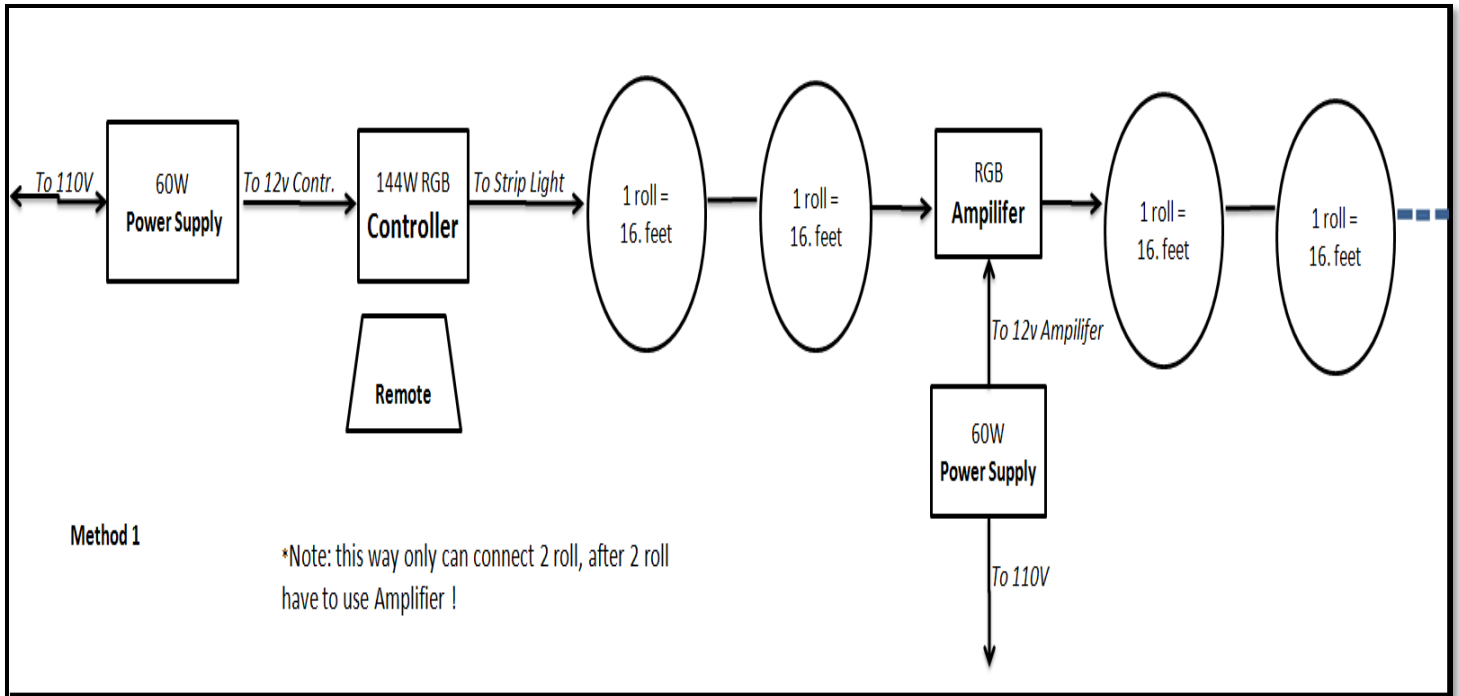

# 12V - COB STRIP LIGHT

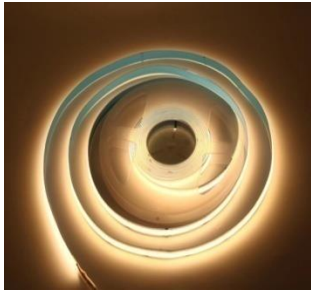

**3000K**

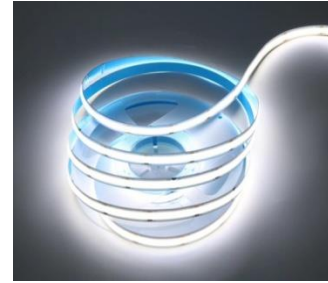

**6000K**

**Item # WS0083**

- ✓ 16.4feet / Roll
- ✓ 12 v Dc
- ✓ PCB (MM)\_8MM
- ✓ 336LED/ M
- ✓ 16W / M
- ✓ 1400LM / M

**Item # WS0084**

- ✓ 16.4feet / Roll
- ✓ 12 v Dc
- ✓ PCB (MM)\_8MM
- ✓ 336LED/ M
- ✓ 16W / M
- ✓ 1400LM / M



**Item # WS 9083**

**Middle Connect**

# 12V H - RGB STRIP LIGHT

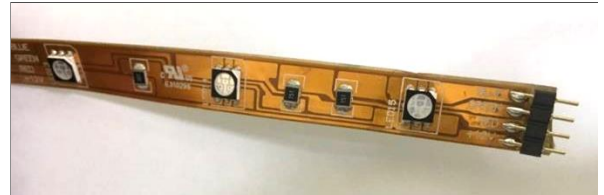

## **NON-WATERPROOF**

*Item # WS0010*

## **WATERPROOF**

*Item # WS0011*

- 4 Pin Male / Female
- 4 Pin / 1 Meter & 4 Pin / 5 Meter
- Use 150pcs 5050LED Chip / Roll
- 16.40 ft. / Roll, DC 12v, 36 W / Roll
- **Best Quality Use: LED Chips, Circuit Board & Components**

### Parts Included



- 25 pcs of clip
- 2 pcs of black rubber cover
- 5 pcs of pin

# 12V M - RGB STRIP LIGHT



M-GRB **300pcs** 5050chip  
4 Pin (Male & Female)

**Waterproof**

**Item # WS0042**

✓ **16.4feet / Roll**

✓ **12 v Dc**

✓ **72 w / Roll**

✓ **4Pin(male,female)/ Roll**



# Accessories for RGB Strip

## Directly Connect These Accessories To The Rolls

Item # WS0096

**N4 T Connector**



❖ Use for single & RGB

Item # WS0097

**N4 L Connector**



❖ Use for single & RGB

Item # WS0098

**N4 Cross Connector**



❖ Use for single & RGB

Item # WS0099

**N4 Middle Connector**



❖ Use for single & RGB

Item # WS0120

**Cross Connector 4 Pin**

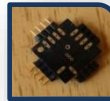

❖ Use for single & RGB

Item # WS0121

**12" Wire Connector 4 Pin**



❖ Use for single & RGB

Item # WS0122

**12" Cable Connector 4 Pin**



❖ Male & Female  
❖ Use for RGB strip

Item # WS0123

**24" Cable Connector 4 Pin**



❖ Male & Female  
❖ Use for RGB strip

## Accessories To Use After Custom Cuts Are Made

Item # WS0124

**M4-Connect Box**



❖ Middle Connector  
❖ 4 clip

Item # WS0126

**M4-Connector 6"**



❖ 4 clip

Item # WS 0130

**T Connector**



Item # WS0125

**H4-Connector 6"**



❖ Head Connector  
❖ 4 clip & 4 wire

Item # WS 0129

**L Connector**



Item # WS 0131

**Cross Connector**



## Other Accessories

Item # WS 0132B

**U Holder**



❖ 1 Meter long  
❖ Clear Plastic

Item # WS0133

**4 Wire Line**



Sell by feet  
❖ 1 Meter long  
❖ Clear Plastic

Item # WS 0132A

**Al Holder**



❖ 1 Meter long  
❖ Aluminum Base &  
Clear Cover

Item # WS0132C

**U Holder**

❖ 1 Meter long  
❖ Clear Plastic

# LED MODULE LIGHT, Water proof , 12V



Item no: **WS 0070**  
Color temp : **RGB** , High Brightness. 5050 LED Chips  
Lumens : 120 Lumens / 3LED Chanel  
Power : 0.72w/ 3LED Chanel  
Length : 5 inch ( Each Module :including wire )



Item no: **WS 0075**  
Color temp : **6000-6500k**, High Brightness. 5730 LED Chips  
Lumens : 165 Lumens / 3LED Chanel  
Power : 1.44w / 3LED Chanel  
Length : 5 inch ( Each Module :including wire )



Item no: **WS 0071**  
Color temp : **3000-3500k**, High Brightness. 5730 LED Chips  
Lumens : 165 Lumens / 3LED Chanel  
Power : 1.44w / 3LED Chanel  
Length : 5 inch ( Each Module :including wire )

# CONTROLLERS & AMPLIFIERS for RGB STRIP

## Item # WS0169

### 44 Keys New Plastic GRB IR Controller



- ✓ Power: 72 W
- ✓ Input: 12 V Output: 6 A

## Item # WS0165

### New Mini RGB RF Controller



- ✓ Power: 144 W ( Can control 1 Roll only ! )
- ✓ Input: 5-24V / Output: 12 V
- ✓ 22 Dynamic mode, 20 Static color

## Item # WS0163

### Aluminum RGB RF Controller 1 to 1



- ✓ Power: 144 W
- ✓ Input: 12-24V / Output: Current: 12V
- ✓ Without Dimmer Function

## Item # WS0161

### New Aluminum RGB RF Controller



- ✓ Power: 144 W
- ✓ Input: 12-24V / Output: Current: 12V
- ✓ With Dimmer Function

## Item # WS0171 Aluminum Amplifier



- ✓ Power: 144 W
- ✓ Input / Output: 12V

## Item # WS0170

### Mini Amplifier



- ✓ Power: 144 W (1 Roll only)
- ✓ Input / Output: 5-24V

# CONTROLLERS for RGB STRIP

## 12V RGB 360W RF CONTROLLER

Item # WS 0166



- **Supply Voltage:** DC5V/12V/24V
- **Remote Control Distance:** 20m
- **Power Output:** 5V/120W, 12V/360W , 24V/576W

## 12V RGB 360W RF CONTROLLER

Item # WC 0001 w/ Touch Remote

Item # WC 0002 w/o Remote

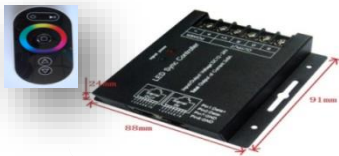

Supply voltage	DC5V, 12V~24V optional (specify the required voltage on orders)
Output current	<8A(each channel)
Output power	5V:<120W, 12V:<360W , 24V:<576W

## Instruction for Job for Both Controller

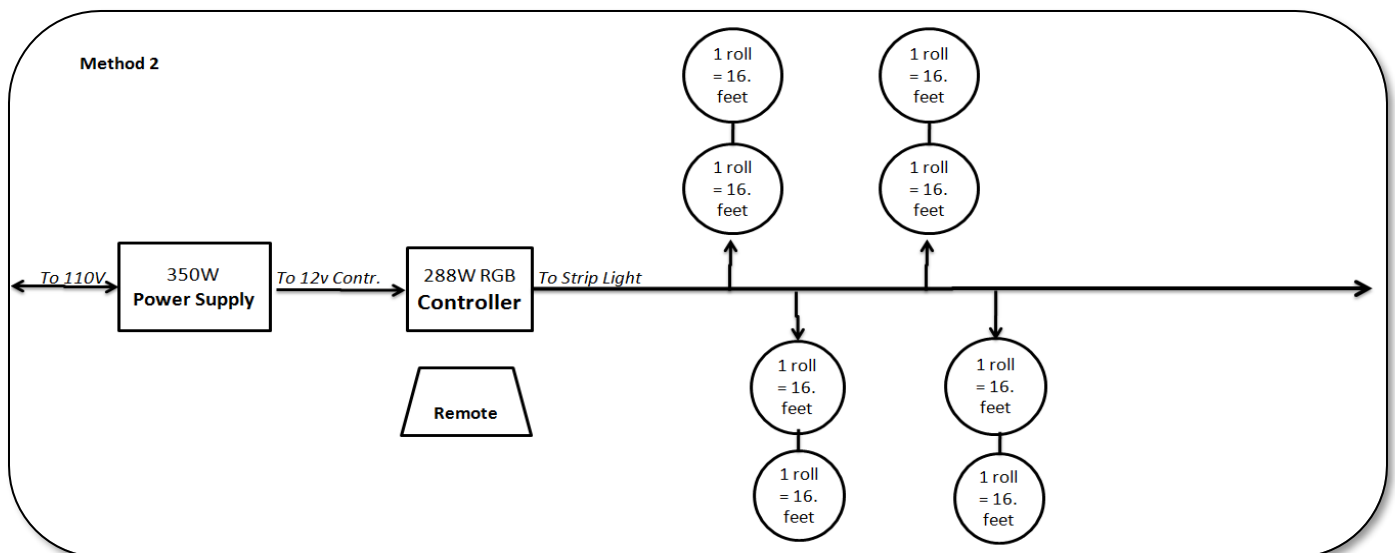

# 12V Single Color Strip Instruction Way

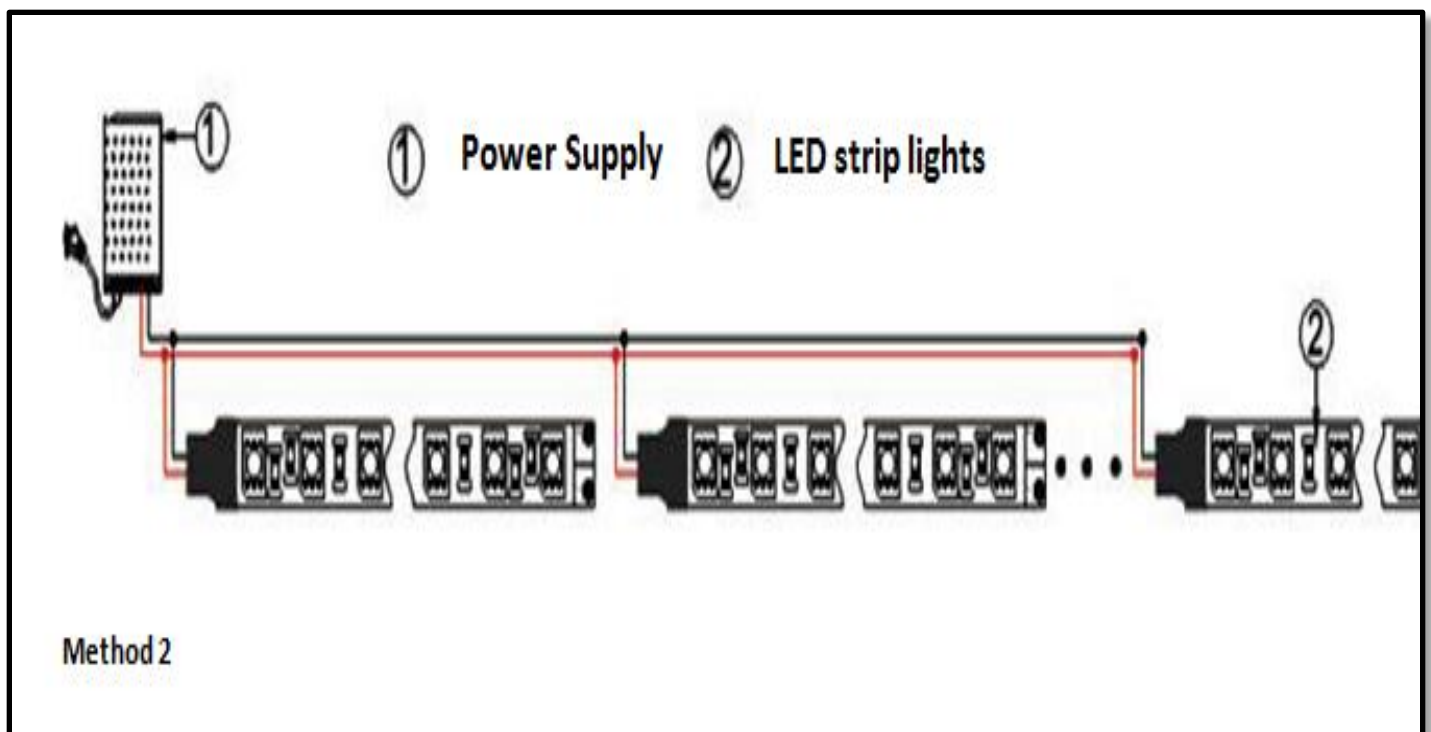
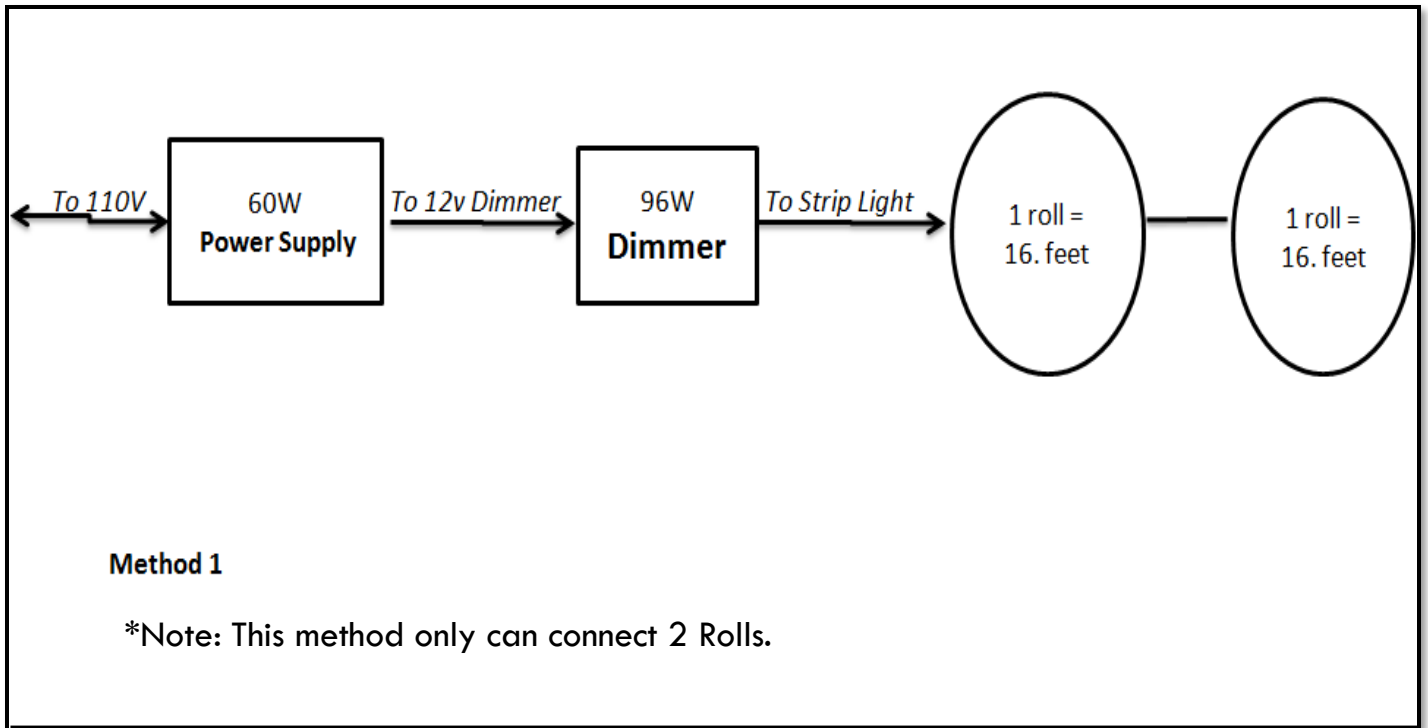

# 12V H - Single Color Strip



**\*H: High Level**

**2700K**

**3000K**

**3500K**

**4500K**

**5500K**

Item # WS0024

Item # WS0020

Item # WS0021

Item # WS0022

Item # WS0023

**\* 12V \* 36W/Roll \* 4 pin Male/Female \***

## ***Parts Included***



- **15" connector 1 pc**
- **20 pcs of clip**
- **2 pcs of black rubber cover**

# Accessories for H-Single Color

## Directly Connect These Accessories To The Rolls

Item # WS0121

**12" Wire Connector 4 Pin**



❖ Use for single & RGB

Item # WS0120

**Cross Connector 4 Pin**

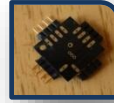

❖ Use for single & RGB

Item # WS0096

**N4 T Connector**



❖ Use for single & RGB

Item # WS0097

**N4 L Connector**



❖ Use for single & RGB

Item # WS0098

**N4 Cross Connector**

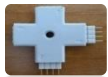

❖ Use for single & RGB

Item # WS0099

**N4 Middle Connector**



❖ Use for single & RGB

## Accessories To Use After Custom Cuts Are Made

Item # WS0124

**M4-Connect Box**



❖ Middle Connector  
❖ 4 clip

Item # WS0125

**H4-Connector 6"**



❖ Head Connector  
❖ 4 clip & 4 wire

Item # WS0126

**M4-Connector 6"**



❖ 4 clip

Item # WS 0129

**L Connector**



Item # WS 0130

**T Connector**



Item # WS 0131

**Cross Connector**



## Other Accessories

Item # WS0127

**15" Connector**



❖ DC & 4Pin Head

Item # WS0128

**T Connector 4 Pin**



❖ DC & 4Pin Head (Male & Female)

Item # WS 0132B

**U Holder**



❖ 1 Meter long  
❖ Clear Plastic

Item # WS0133

**4 Wire Line**



Sell by feet

Item # WS 0132A

**Al Holder**



❖ 1 Meter long  
❖ Aluminum Base & Clear Cover

Item # WS 0132C

**U Holder**

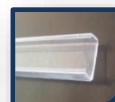

❖ 1 Meter long  
❖ Clear Plastic

# 12V M – Single Color 300 /Roll



- 300 pcs 5050 LED chip/roll
- 12V
- 16.4Ft./Roll
- DC head male/female
- 48 W /Roll

<p><b><u>3000K</u></b> use 300 pcs 5050 LED chip/ roll</p>	<p><b>None Waterproof</b> Item# WS 0043</p>	<p><b>Waterproof</b> Item# WS 0043W</p>
<p><b><u>5500K</u></b> use 300 pcs 5050 LED chip/ roll</p>	<p><b>None Waterproof</b> Item# WS 0044</p>	<p><b>Waterproof</b> Item# WS 0044W</p>
<p><b><u>Green</u></b> use 300 pcs 5050 LED chip/ roll</p>	<p><b>Waterproof</b> Item# WS 0065</p>	
<p><b><u>Blue</u></b> use 300 pcs 5050 LED chip/ roll</p>	<p><b>Waterproof</b> Item# WS 0066</p>	
<p><b><u>Red</u></b> use 300 pcs 5050 LED chip/ roll</p>	<p><b>Waterproof</b> Item# WS 0067</p>	
<p><b><u>Yellow</u></b> use 300 pcs 5050 LED chip/ roll</p>	<p><b>Non Waterproof</b> Item# WS 0068</p>	

Item # WS0116  
N2 T Connector



Item # WS0117  
N2 L Connector

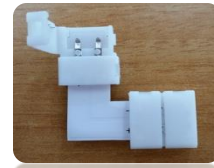

Item # WS0118  
N2 Cross Connector

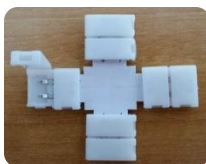

Item # WS0109  
N2 Connector 6"



Item # WS0119  
N2 Connect Box



Accessories' details on P. 11



# ACCESSORIES for M-SINGLE COLOR

Use for 600 pcs LED chip

Use for 300 pcs LED chip

Item # WS0114

**3DC Power Feet**

❖ Use for M-Single color strip lights



Item # WS0115

**1DC Power Feet**

❖ Use for M-Single color strip lights



Item # WS0110

**M2 Connect Box**

❖ Middle Connector  
❖ 2 clip



Item # WS0112

**H2 Connector 6"**

❖ With DC Head  
❖ 2 clip & 2 wire



Item # WS0111

**M2 connector 6"**

❖ 2 clip



Item # WS0116

**N2 T Connector**

❖ Middle Connector  
❖ 2 clip

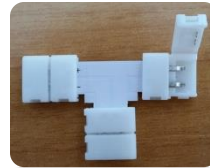

Item # WS0117

**N2 L Connector**

❖ Middle Connector  
❖ 2 clip



Item # WS0118

**N2 Cross Connector**

❖ Middle Connector  
❖ 2 clip



Item # WS0119

**N2 Connect Box**

❖ Middle Connector  
❖ 2 clip



Item # WS0109

**N2 Connector w/ DC**

❖ With DC Head  
❖ 2 clip



Item # WS0108

**N2 Connector 6"**

❖ 2 clip



# *DIMMER for SINGLE COLOR*

## **Item # WS0182 Mini Dimmer w/ Remote**



- Power: 144W
- Input: DC5-24V
- Output: 12A

## **Item # WS0180 Dimmer Set**



- Power: 96W
- Input: DC12-24V
- Output: 8A

## **Item # WS0181 Dimmer for Wall w/ Remote**



- Power: 72W
- Size: L3 3/8" x W3 3/8" x H1 5/8"
- Supply: DC12-24v, Current: 6A

# *H - CHASING STRIP LIGHT*



## **Waterproof**

**Item # WS0002**

- **114 Modes of Chasing Color Change**
- **Use 150pcs 5050LED Chip / Roll, 5 Pin Male/Female**
- **16.40 feet / Roll, DC 12v, 36 w / Roll**

## **Parts Included**



- **25 pcs of clip**
- **2 pcs of pin**
- **2 pcs of black rubber cover**

# H-CHASING ACCESSORIES

**Item # WS0164**

## ***Chasing Controller***



- ❖ Effect Mode= 114 modes of chasing color change
- ❖ Input/Output: DC12v only
- ❖ Current: <60MA
- ❖ Use for **High Level Chasing Strip**

**Item # WS0100**

## ***T Connector 5 Pin***



- ❖ Power Supply Connect
- ❖ Pin Connect
- ❖ Use for High Level Chasing

**Item # WS0101**

## ***12" Wire Connector 5 Pin***



- ❖ Use for High Level Chasing

**Item # WS0102**

## ***Cross Connector 5 Pin***

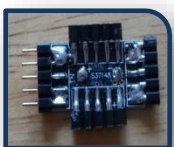

- ❖ Use for High Level Chasing

# TRANSFORMERS OUTPUT 12V

## **150W IP20** POWER SUPPLY ( INDOOR )

Item # WS 150WIP20



- Input: AC 110-260V
- Output: DC 12V 12.5A

## **150W IP65** POWER SUPPLY ( OUTDOOR )

Item # WS 150WIP65



- Input: AC 110-260V
- Output: DC 12V 12.5A

## **250W IP20** POWER SUPPLY ( INDOOR )

Item # WS 0143



- Input: AC 110-260V
- Output: DC 12V 20A

## **250W IP65** POWER SUPPLY ( OUTDOOR )

Item # WS 250WIP65



- Input: AC 110-260V
- Output: DC 12V 20A

## **350W IP20** POWER SUPPLY ( INDOOR )

Item # WS 0144



- Input: AC 110-220V
- Output: DC 12V 29A

# TRANSFORMERS OUTPUT 12V

## 24W POWER SUPPLY ( INDOOR )

Item # WS 0140



- Input: AC100-240V
- Output: DC 12V 2A

## 60W POWER SUPPLY ( INDOOR )

Item # WS 0141



- Input: AC100-240V
- Output: DC 12V 5A

## 60W IP20 POWER SUPPLY ( INDOOR )

Item # WS 60WIP20



- Input: AC100-240V
- Output: DC 12V 5A

## 60W IP65 POWER SUPPLY ( OUTDOOR )

Item # WS 60WIP65



- Input: AC100-240V
- Output: DC 12V 5A

## 96W POWER SUPPLY ( INDOOR )

Item # WS 0142



- Input: AC100-240V
- Output: DC 12V 8A





# Light Bulbs

## GU10/PAR20 30 light bulbs



- ❖ 110 -130V AC
- ❖ CRI > 80
- ❖ Dimmable
- ❖ 3 years warranty
- ❖ Bean Angle: 38°
- ❖ Replacement: 75W



Item#	Description	Watt	Temp. Color	Lumen	hours	Feature	
	WB 6330	GU10 3000K	8W	3000K	500	25000	Dim
	WB 6350	GU10 5000K	8W	5000K	500	25000	Dim
	WB 7387WW	PAR20 3000K	8W	3000K	500	25000	Dim
	WB 7387DL	PAR20 5000K	8W	5000K	500	25000	Dim
	WB 7388WW	PAR30 short neck 3000K	10W	3000K	800	25000	Dim
	WB 7388DL	PAR30 short neck 5000K	10W	5000K	800	25000	Dim
	WB 7370WW	PAR38	16W	3000K	1300	Dim	

# NEW ITEMS OF 2022

## LIGHT BULBS



### GU10 9W 2700K

#### Item# WB8327

- ⇒ 9W
- ⇒ 120V, 60HZ 600 Lumens
- ⇒ CRI>90
- ⇒ 38 Degree
- ⇒ Dimmable



### GU10 9W 3000K

#### Item# WB8330

- ⇒ 9W
- ⇒ 120V, 60HZ 600 Lumens
- ⇒ CRI>90
- ⇒ 38 Degree
- ⇒ Dimmable



### GU10 9W 5000K

#### Item# WB8350

- ⇒ 9W
- ⇒ 120V, 60HZ 600 Lumens
- ⇒ CRI:>90
- ⇒ 38 Degree
- ⇒ Dimmable



# LIGHT BULBS

## Middle Level Bulbs



**8MR16/DL**

**Item# WB7102**

- ⇒ 12V, Daylight, 470Lumens
- ⇒ Bi-Pin GU5.3, 38 Degree, Dimmable for Magnet!
- ⇒ 8 Watts



**7E26/DL**

**Item# WB7305**

- ⇒ 120V, Daylight, 360Lumens
- ⇒ 38 Degree, Dimmable !
- ⇒ 7 Watts

## L.E.D 12V MR16 LIGHT **UL APPROVE**

**MR16**



**WB 8103**

UL MR16 9W Warm White

- ⇒ Color Temp.: 2700K
- ⇒ Beam Angle: 38°
- ⇒ 800 Lumen, Dimmable!
- ⇒ Citizen LED Chip

**MR16**



**WB 7107**

MR16 8W Daylight

- ⇒ Color Temp.: 5000K
- ⇒ Beam Angle: 38°
- ⇒ 500 Lumen, Dimmable!

# L.E.D LIGHT



## High Level Bulbs

### Par 20



**WB 7325 CL,** 10W 4000K 650 Lumens Dimmable !

### Par 30



**WB 7326 WW,** 17W 3000K 1100 Lumens Dimmable !

**WB 7326 CL,** 17W 4000K 1100 Lumens Dimmable !

### Par 38



**WB 7327 WW,** 24W 3000K 1600 Lumens Dimmable !



**WB 7329 WW**

**BR30 2700K** 17W 1100 Lumens, Dimmable!

**WB 7329 DL**

**BR30 5000K** 17W 1100 Lumens, Dimmable!



**WB 7330 WW**

**BR40 2700K** 25W 1600 Lumens, Dimmable!

# OUTDOOR FLOOD LIGHT

## 20W RGB w / REMOTE

Item # WO RGB20



- ❑ LED type: COB
- ❑ Power :20W
- ❑ Dimension:4.5"x3.5"x4"
- ❑ Input (V): 85~265V AC
- ❑ Lifespan: ≥50,000H
- ❑ Material: Aluminum
- ❑ IP grade: IP65
- ❑ Warranty: 5 years

## 30W (DAYLIGHT)

Item # WO 4130



- ❑ Power: 30W
- ❑ Voltage: AC90-260V
- ❑ Luminous Flux: >1400lm
- ❑ Beam Angle: 120 Degrees
- ❑ Color Temp: Daylight
  - ❑ 6000-5000K
- ❑ Dimension: 7"x5.5"x4.5"
- ❑ Material: Aluminum
- ❑ Life Span: 50,000 hrs
- ❑ IP Grade: IP65

## 20W PIR MOTION SENSOR (DAYLIGHT)

Item # WO 4120M



- ❑ LED type: COB
- ❑ Power :20W
- ❑ Size:4.5"x6.5"x4"
- ❑ Input (V): 85~265V AC
- ❑ Lifespan: ≥50,000H
- ❑ Material: Aluminum
- ❑ IP grade : IP54;IP65
- ❑ Warranty:5 years

## 30W PIR MOTION SENSOR (DAYLIGHT)

Item # WO 4130M



- ❑ 200W Replacement
- ❑ Water-proof
- ❑ Color Temp: 6000-5000K
- ❑ Dimension: 7"x7.5"x4.5"
- ❑ Input:AC85-285V
- ❑ Angle: 120 Degrees
- ❑ Life Span: 50,000 hrs

# OUTDOOR FLOOD LIGHT

## 50W (DAYLIGHT)

Item # WO 4150



- Power :50W
- Dimension: 24.6\*19\*4.2cm
- Voltage: AC85-265V
- Luminous Flux:  $\geq 110\text{Lm/W}$
- Material: Aluminum
- Color Temp: Daylight
- IP grade : IP65

## 50W RGB w / REMOTE

Item # WO RGB50



- LED type: COB
- Power :50W
- Dimension: 11"x9"x5.5"
- Input (V): 90~260V AC
- Lumens: 0 - 3850 lm
- Material: Aluminum
- IP grade: IP65

## 100W

Item # WO 4100 & WO 4140



- Power: 100W
- Voltage: AC90-260V
- Luminous Flux:  $> 8400\text{ lm}$
- Color Temp: 4000k&6000k
- Dimension: 14"x10"x3.5"
- Material: Aluminum
- IP Grade: IP65

## 200W

Item # WO 4300 & WO 4340



- Power: 200W
- Voltage: AC85-265V
- Luminous Flux:  $\geq 110\text{Lm/W}$
- Color Temp: 4000k&6000k
- Dimension: 46.1\*30.3\*4.9cm
- Material: Aluminum
- IP Grade: IP65

# T5 LED TUBE

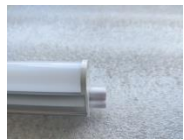
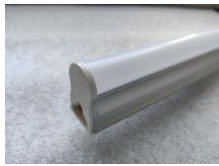

Item No	WT 5301	WT 5501	WT 5302	WT 5502	WT 5303	WT 5503	WT 5304	WT 5504
Length	1 Ft.	1 Ft.	2 Ft.	2 Ft.	3 Ft.	3 Ft.	4 Ft.	4 Ft.
Color Temp.	2700K	5500K	2700K	5500K	2700K	5500K	2700K	5500K
Power (W)	5W	5W	10W	10W	13W	13W	20W	20W
Luminous	450±8%	450±8%	900±8%	900±8%	1000±8%	1000±8%	1700±8%	1700±8%

## T5 ACCESSORIES

Item No.	Description
WT 5001	4 Feet Power Cord
WT 5002	12 Inch Middle Connector



## INSTALLATION

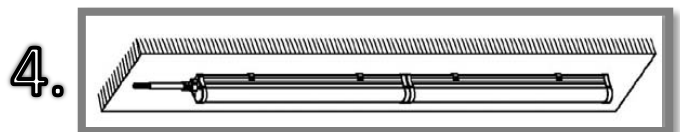
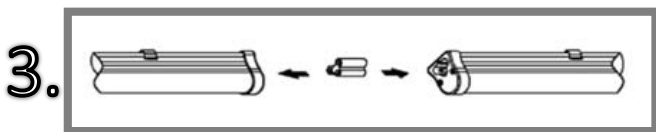
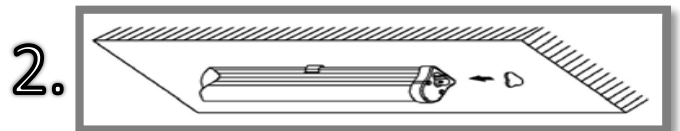
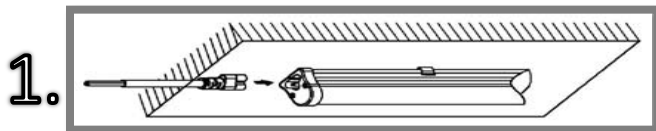

# T8 LED TUBE



**Type A + B W/O ballasts !**

## Clear Cover

Item No	WT 4F18W5KC	WT 4F18W6KC	WT 8302	WT 8502
Length	4 Ft.	4 Ft.	2 Ft.	2Ft.
Color Temp.	5000K	6000K	3000K	60000k
Power (W)	18W	18W	9W	9W
Lumens	>2100lm	>2100lm	AC 85-265	AC85-265



## Frost Cover

Item No	WT 4F18W5KF	WT 4F18W6KF	WT 8312	WT 8512
Length	4 Ft.	4 Ft.	2 Ft.	2 Ft.
Color Temp.	5000K	6000K	3000K	6000k
Power (W)	18W	18W	10W	10W
Lumens	>2100lm	>2100lm	AC 85-265	AC85-265



# T8 LED TUBE



**No ballast !**

## Clear Cover



Item No	WT 8508 Type B	WT 8504 Type B	WT 8304 Type A	WT 8404 Type A
Length	8 Ft.	4Ft.	4 Ft.	4 Ft.
Color Temp.	6000K	5000K	3000K	4000K
Power (W)	40W	20W	20W	20W
Put In	AC 85 - 265	AC 85 - 265	AC 85 - 265	AC 85 - 265

## Frost Cover



Item No	WT 8108 Type B	WT 8514 Type B	WT 8314 Type A	WT 8414 Type A
Length	8Ft.	4Ft.	4 Ft.	4 Ft.
Color Temp.	6000K	5000K	3000K	4000K
Power (W)	40W	20W	20W	20W
Put In	AC 85 - 265	AC 85 - 265	AC 85 - 265	AC 85 - 265

# T8 LED TUBE



**Compatible! Dimmable! Both Sides power in !**

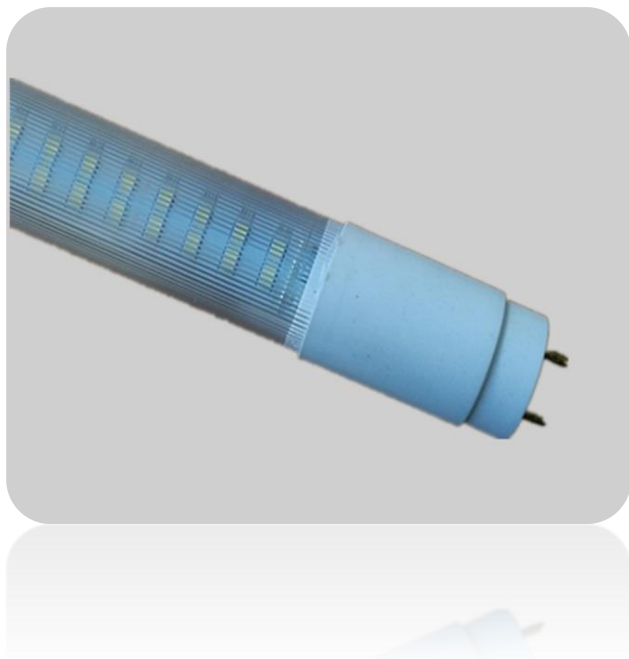

## Description:

- Compatible
- Ballast
- Dimmable
- Life Time: 50000H

Item No	Length	Color Temp.	Cover	Power(W)	Input	Lumens
WT 8554	4 Ft.	5000K	Clear	18W	AC 85 - 265	1800
WT 8654	4 Ft.	6500K	Clear	18W	AC 85 - 265	1800



# T8 Fixture & Accessory

## ITEM NO.: WT 8012

- 2 ft. T8 use
- Dimension: 24.5"x1.5"x1"



## ITEM NO.: WT 8022

- 2 ft. T8 use
- Dimension: 24.5"x3"x1.5"



## ITEM NO.: WT 8014

- 4 ft. T8 use **(UL Approved)**
- Dimension: 48.5"x1.5"x1"



## ITEM NO.: WT 8024

- 4 ft. T8 use **(UL Approved)**
- Dimension: 48.5"x3"x1.5"



## ITEM NO.: WT 8018

- 8 ft. T8 use **(UL Approved)**
- Single Tube
- Dimension: 96.5"x2.0"x1.6"



## ITEM NO.: WT 8028

- 8 ft. T8 use **(UL Approved)**
- Double Tube
- Dimension: 96.5"x3.3"x1.6"



# Integrate V - T8

*Use for AC 100V - 277V*



• WT 8802 2FT. 18W 6000K 96Pcs  
SMD2853, Alum.+PC

• WT 8804 4FT. 30W 6000K 192Pcs  
SMD2853, Alum.+PC

• WT 8806 6FT. 40W 6000K 288Pcs  
SMD2853, Alum.+PC

• WT 8808 8FT. 60W 6000K 384Pcs  
SMD2853, Alum.+PC

Extra Parts

WT 5002 12" Middle Connector

WT 5001 5FT. Power Cord w/  
Switch



# 3"4" LED Adjust Gimbal Light



## Item No. : WR 8000

- Gyre head
- Dimmable
- 120VAC 50/60Hz
- Wattage: 8W 960 Luminous
- 3000K/4000K/5000K CCT changeable
- 24° Beam Angle



## Adjust Trim



Item No. : WR 803  
3" white trim



Item No. : WR 804  
4" white trim

# LED DESK LAMP

**Item # WD 290**

**White**

w/o USB Port



- ✓ **Power:** 12W
- ✓ **Input:** DC12V
- ✓ **Adjustable Color**  
**Temperature:** 3000K~6000K
- ✓ **Desk Lamp Size:**  
41\*18\*20\*44cm
- ✓ **Beam Angle:** 140 degree
- ✓ **Long Lifespan:** 50,000h
- ✓ **Warranty:** 2 years
- ✓ **Dimmable:** Stepless
- ✓ **Safe To Touch**
- ✓ **No Radiation ! No Ultraviolet**  
**! No Flash !**