

Wei's - l.e.d[®]

2024 Catalog

Wei's International Trading Corp

718-815-5600

weisled@msn.com

3 -COLOR IN 1 TRACK LIGHTING



Item No:

WG532B & WG532W

Wattage:**20W** Black & White

CCT:3000K/4000K/5000K

Item No:

WG 531B & WG 531W

Wattage:**10W** Black & White

CCT:3000K/4000K/5000K

■ BLACK

□ WHITE

❖ *3CCT changeable : 3000k /4000k /5000k*

❖ *38 ° Angle*

❖ *Dimmable !*

❖ *CRI > 90*

❖ *Input:*

120V / 50-60 Hz

❖ *Chip Brand:*

Bridgelux LED

❖ *Warranty:*

3 Years



3 COLOR TEMP. CCT



Item No.

WG 312B & WG 312W

12W Black & White

Size: L 4.75" x W 2.4" x H 6.3"

WG 325B & WG 325W

25W Black & White

Size: L 5.1" x W 3.15" x H 7.1"

■ BLACK

□ WHITE

❖ *3CCT changeable : 3000k /4000k /5000k*

❖ *38 ° Angle*

❖ *Dimmable !*

❖ *CRI > 80*

❖ *Input:*

❖ *Chip Brand:*

❖ *Warranty:*

120V / 50-60 Hz

Bridgelux LED

4 Year

Wei's - l.e.d

5CCT Changeable

LED TRACK LIGHT



■ BLACK

□ WHITE

❖ 5 CCT changeable

❖ 38° Angle

❖ Dimmable

❖ CRI > 90

❖ 1000 Lumens

❖ Input: 120V / 50-60 Hz

❖ Warranty: 30000 hours

5CCT changeable:
2000K/3000K/4000K
/5000K/6000K

Item No.

WG 551B & WG 551W

10W Black & White

Size: 2.95"x 2.36"x 5.1"

GU10 TRACK LIGHT



■ BLACK

□ WHITE

❖ *Item No. WG 85B*

❖ *Watt: GU10/ Max 50W*

❖ *Voltage: 120V / 50-60 Hz*

❖ *Item No. WG 85W*

❖ *Watt: GU10/ Max 50W*

❖ *Voltage: 120V / 50-60 Hz*

Measurement: "mm"

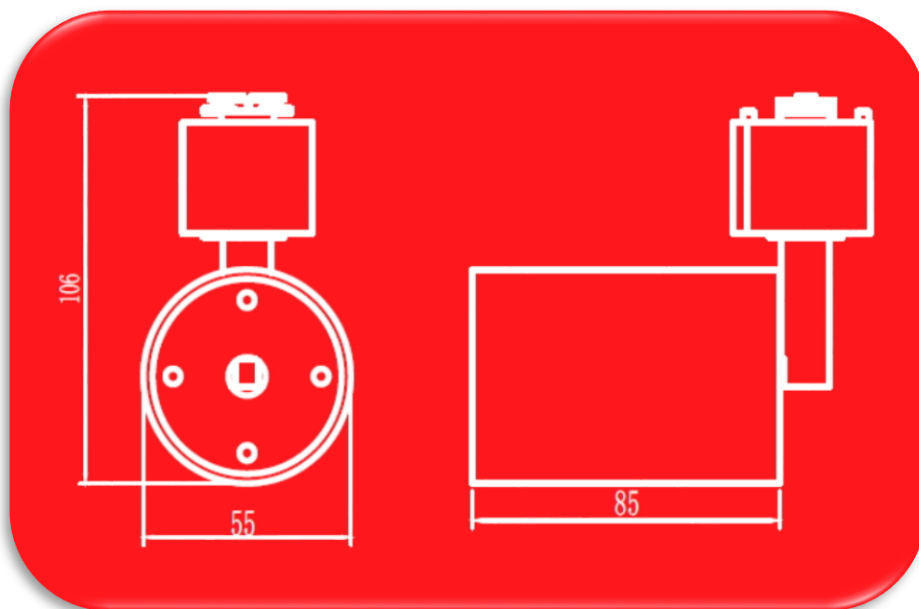

Not include GU10 Light Blub

LED TRACK LIGHT



- BLACK □WHITE
- ❖24° Angle
- ❖come w/ 38° lens
- ❖Lums: 789

WG 105B
WG 105W
 10W 5000K



- BLACK □WHITE
- ❖38° Angle
- ❖come w/ 24° lens
- ❖Lums: 1315

WG 155B
WG 155W
 15W 5000K

AC 120V / 24° & 38°
 BEAM / DIMMABLE



- BLACK □WHITE
- ❖38° Angle
- ❖come w/ 24° lens
- ❖Lums: 3295

WG 353W
 35W 3000K
WG 355B
WG 355W
 35W 5000K



LED TRACK LIGHT



■ BLACK

□ WHITE

- ❖ *36° Angle*
- ❖ *Dimmable*
- ❖ *CRI > 80*
- ❖ *Light Efficiency: 80 Lums/W*
- ❖ *Track Head: Halo*
- ❖ *Input: 120V / 50-60 Hz*
- ❖ *Chip Brand: Philips*
- ❖ *Warranty: 3 years*

Exchange Lens
15° -25°
Angle



WG 012 /12W
WG 025 /25W

Item No.

WG 1123W

12W 3000K

WG 1125B & WG 1125W

12W 5000K

Size: 6" x 2 1/2" x 6 1/4"

WG 1253W

25W 3000K

WG 1255B & WG 1255W

25W 5000K

Size: 7 1/4" x 3 1/8" x 7"

5 Color Temp. CCT



WR 4500

4" 10W CCT

2700K/3000K/3500K/4000K/5000K

WR 6500

6" 15W CCT

2700K/3000K/3500K/4000K/5000K

- ◆ *5 Year Warranty !*
- ◆ *10w Replace 75w & 15w Replace 100w !*
- ◆ *Ultra Thin 1.1 inch Height Only !*
- ◆ *2700K-3000K-3500K-4000K-5000K Changeable*

COB 120V LED STRIP



ETL approve

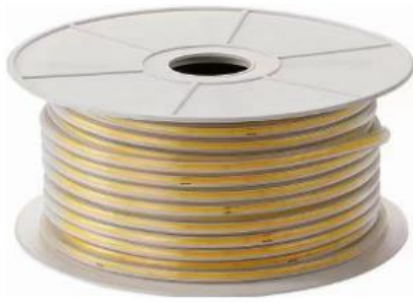

WS 0036

3000K COB LED Strip

- 90-130V Strip light
- IP65 Waterproof
- 3.5W Per Foot
- 90 CRI
- 300 Lumens Per Foot
- Cut Points Every 10"
- 50M=165 Ft./roll
- 8mm PVC Cobb Tape
- Temp: -15°C~45°C
- 2 Year Warranty

WS 0037

6000K COB LED Strip

- 90-130V Strip light
- IP65 Waterproof
- 3.5W Per Foot
- 90 CRI
- 300 Lumens Per Foot
- Cut Points Every 10"
- 50M=165 Ft./roll
- 8mm PVC Cobb Tape
- Temp: -15°C~45°C
- 2 Year Warranty

ACCESSORIES

Power Cord

*8 Foot Aluminum Channel

Plastic Clip for 120V

120V End Caps

Item # WS0138C



Item # WS0132C

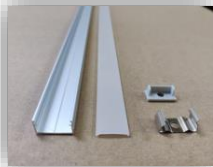

Item # WS0135



Item # WS0136



COB 12" Strip Light Middle Connector

Item # WS0137C



110V 5050 RGB LED STRIP

WS 0030

165 ft./ Roll



- 110v RGB Striplight
- < 9W/ 3.3 Ft.
- 60 led Chips / Meter
- 14-16Lm. per LED Chip

WS 0035

330 ft./ Roll

- 19.68 INCHES/cut
- 15mm Wide
- Temp: -30°c-45°c
- 100-130V AC IP67

WS 0156

- 110v RGB IR Controller 165ft.
- Input: 100-130V
- Current: 3*3A
- Power: 750W
- Control 160 Ft.
- 24 Key remote controller



WS 0155

- 110v RGB RF Controller 165ft.
- Input: 100-130V
- Current: 3*3A
- Power: 800W
- Control 160 Ft.
- 24 Key remote controller



ACCESSORIES



Item # WS0137

- * 9" Jump Feet
- * Use from Power to Strip Only



Item # WS0138

- * Power Cord

110V 5050 Single Color LED STRIP

WS 0034 (3000K) & WS 0033 (6000K)

165 ft./ Roll



- 165 ft./ Roll
- 6W / 3.3 Ft.
- 60 led Chips / Meter
- 20-22Lm per LED Chip
- 1 meter/cut
- 15mm Wide
- Temp: -30°C-45°C
- 100-130V AC IP67

ACCESSORIES



Item # WS0137S

*Middle Jump feet from Strip to Strip, 12" Length

ACCESSORIES

Item # WS0138S

Power Cord



Aluminum Channel

Use For 12V & 110V Strips

Item # WS 0132B

- ❖ 1 Meter long = 3.3 Ft.
- ❖ Aluminum Base & Frost Cover

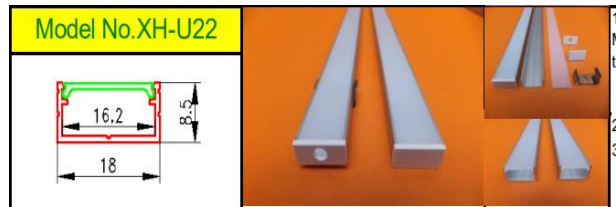

Item # WS 0132C

- ❖ 8 ft. long
- ❖ Aluminum Base & Frost/Clear Cover
- ❖ 8.5 mm deep

Item # WS 0132D

- ❖ 8 ft. long
- ❖ Aluminum Base & Frost/Clear Cover
- ❖ 13 mm deep

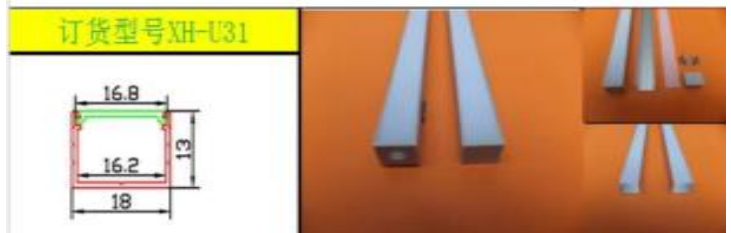

Item # WS 0192

- ❖ 8 ft. long
- ❖ Aluminum Base & Frost/Clear Cover
- ❖ 10 mm deep



Instruction for 12v RGB Strip

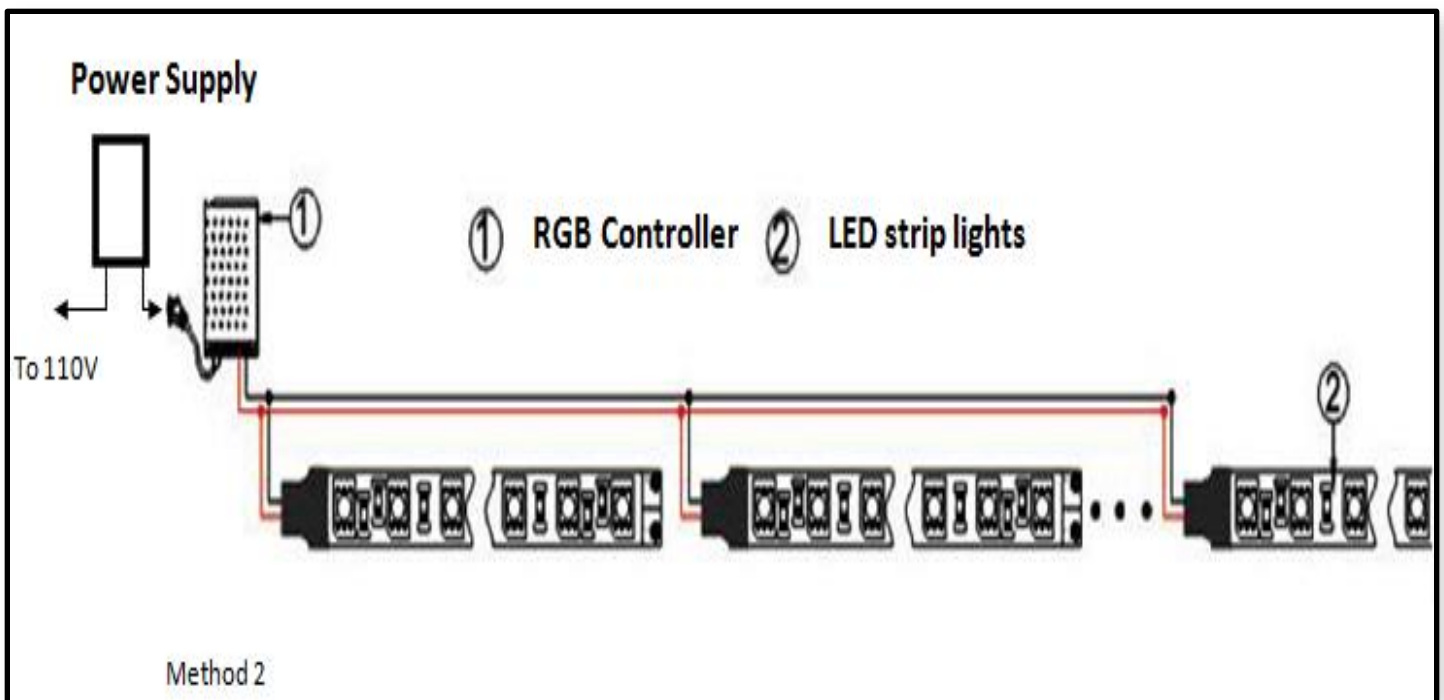
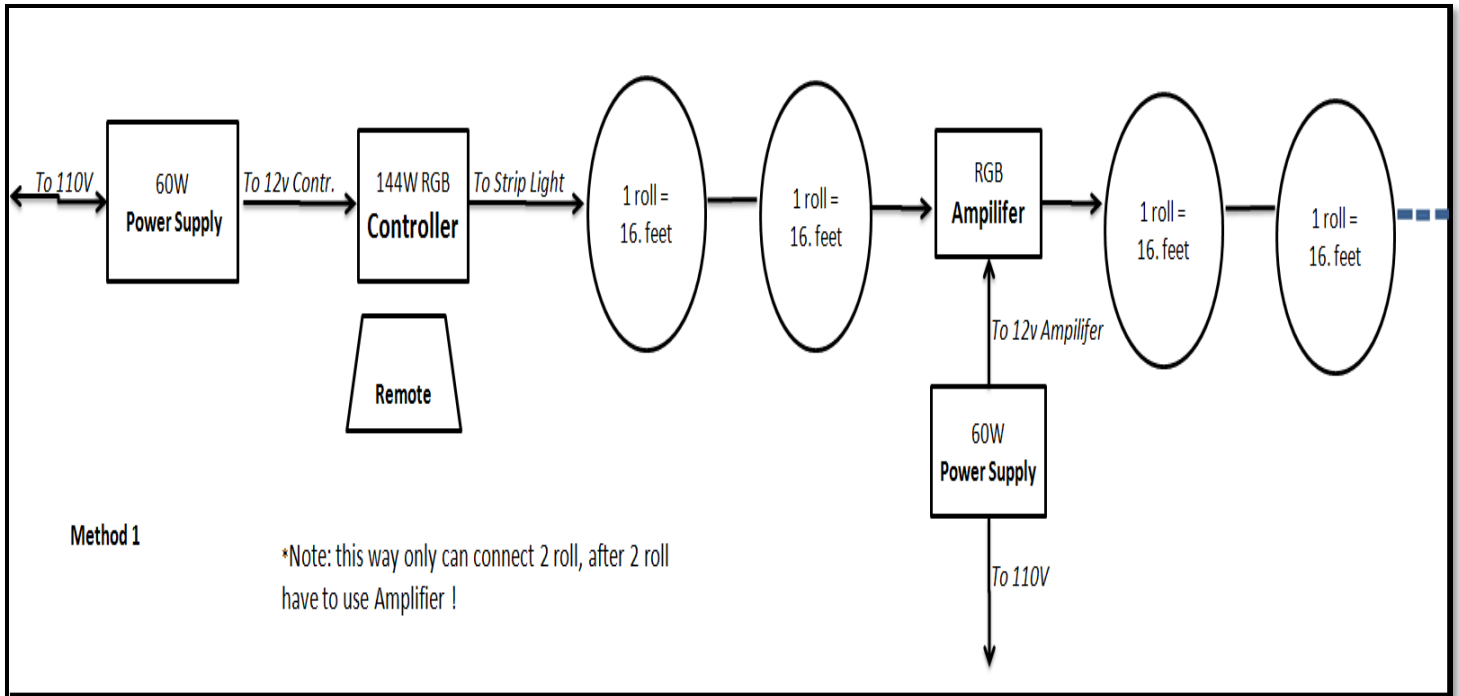

12V - COB STRIP LIGHT

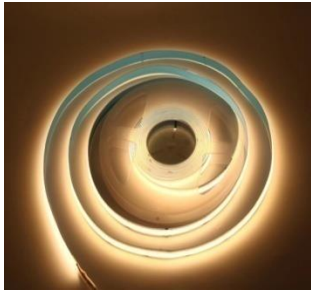

3000K

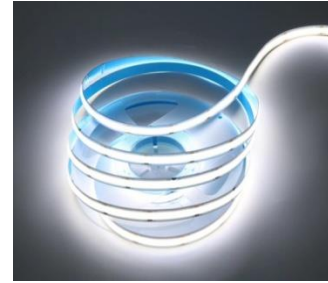

6000K

Item # WS0083

- ✓ 16.4feet / Roll
- ✓ 12 v Dc
- ✓ PCB (MM)_8MM
- ✓ 336LED/ M
- ✓ 16W / M
- ✓ 1400LM / M

Item # WS0084

- ✓ 16.4feet / Roll
- ✓ 12 v Dc
- ✓ PCB (MM)_8MM
- ✓ 336LED/ M
- ✓ 16W / M
- ✓ 1400LM / M



Item # WS 9083

Middle Connect

12V H - RGB STRIP LIGHT

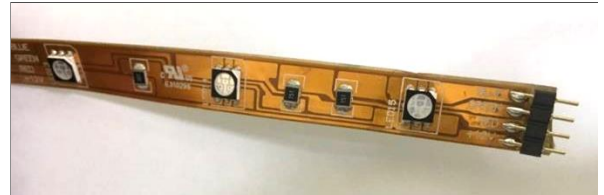

NON-WATERPROOF

Item # WS0010

WATERPROOF

Item # WS0011

- 4 Pin Male / Female
- 4 Pin / 1 Meter & 4 Pin / 5 Meter
- Use 150pcs 5050LED Chip / Roll
- 16.40 ft. / Roll, DC 12v, 36 W / Roll
- **Best Quality Use: LED Chips, Circuit Board & Components**

Parts Included



- 25 pcs of clip
- 2 pcs of black rubber cover
- 5 pcs of pin

12V M - RGB STRIP LIGHT



M-GRB **300pcs** 5050chip
4 Pin (Male & Female)

Waterproof

Item # WS0042

✓ **16.4feet / Roll**

✓ **12 v Dc**

✓ **72 w / Roll**

✓ **4Pin(male,female)/ Roll**

Accessories for RGB Strip

Directly Connect These Accessories To The Rolls

Item # WS0096

N4 T Connector



❖ Use for single & RGB

Item # WS0097

N4 L Connector



❖ Use for single & RGB

Item # WS0098

N4 Cross Connector

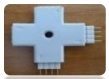

❖ Use for single & RGB

Item # WS0099

N4 Middle Connector



❖ Use for single & RGB

Item # WS0120

Cross Connector 4 Pin

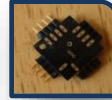

❖ Use for single & RGB

Item # WS0121

12" Wire Connector 4 Pin



❖ Use for single & RGB

Item # WS0122

12" Cable Connector 4 Pin



❖ Male & Female
❖ Use for RGB strip

Item # WS0123

24" Cable Connector 4 Pin



❖ Male & Female
❖ Use for RGB strip

Accessories To Use After Custom Cuts Are Made

Item # WS0124

M4-Connect Box



❖ Middle Connector
❖ 4 clip

Item # WS0126

M4-Connector 6"



❖ 4 clip

Item # WS 0130

T Connector



Item # WS0125

H4-Connector 6"



❖ Head Connector
❖ 4 clip & 4 wire

Item # WS 0129

L Connector



Item # WS 0131

Cross Connector



Other Accessories

Item # WS 0132B

U Holder



❖ 1 Meter long
❖ Clear Plastic

Item # WS0133

4 Wire Line



Sell by feet
❖ 1 Meter long
❖ Clear Plastic

Item # WS 0132A

Al Holder



❖ 1 Meter long
❖ Aluminum Base &
Clear Cover

Item # WS0132C

U Holder

❖ 1 Meter long
❖ Clear Plastic

LED MODULE LIGHT, Water proof , 12V



Item no: **WS 0070**
Color temp : **RGB** , High Brightness. 5050 LED Chips
Lumens : 120 Lumens / 3LED Chanel
Power : 0.72w/ 3LED Chanel
Length : 5 inch (Each Module :including wire)



Item no: **WS 0075**
Color temp : **6000-6500k**, High Brightness. 5730 LED Chips
Lumens : 165 Lumens / 3LED Chanel
Power : 1.44w / 3LED Chanel
Length : 5 inch (Each Module :including wire)



Item no: **WS 0071**
Color temp : **3000-3500k**, High Brightness. 5730 LED Chips
Lumens : 165 Lumens / 3LED Chanel
Power : 1.44w / 3LED Chanel
Length : 5 inch (Each Module :including wire)

CONTROLLERS & AMPLIFIERS for RGB STRIP

Item # WS0169

44 Keys New Plastic GRB IR Controller



- ✓ Power: 72 W
- ✓ Input: 12 V Output: 6 A

Item # WS0165

New Mini RGB RF Controller



- ✓ Power: 144 W (Can control 1 Roll only !)
- ✓ Input: 5-24V / Output: 12 V
- ✓ 22 Dynamic mode, 20 Static color

Item # WS0163

Aluminum RGB RF Controller 1 to 1



- ✓ Power: 144 W
- ✓ Input: 12-24V / Output: Current: 12V
- ✓ Without Dimmer Function

Item # WS0161

New Aluminum RGB RF Controller



- ✓ Power: 144 W
- ✓ Input: 12-24V / Output: Current: 12V
- ✓ With Dimmer Function

Item # WS0171 Aluminum Amplifier



- ✓ Power: 144 W
- ✓ Input / Output: 12V

Item # WS0170

Mini Amplifier



- ✓ Power: 144 W (1 Roll only)
- ✓ Input / Output: 5-24V

CONTROLLERS for RGB STRIP

12V RGB 360W RF CONTROLLER

Item # WS 0166



- **Supply Voltage:** DC5V/12V/24V
- **Remote Control Distance:** 20m
- **Power Output:** 5V/120W, 12V/360W , 24V/576W

12V RGB 360W RF CONTROLLER

Item # WC 0001 w/ Touch Remote

Item # WC 0002 w/o Remote

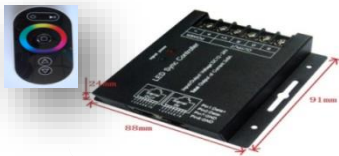

Supply voltage	DC5V, 12V~24V optional (specify the required voltage on orders)
Output current	<8A(each channel)
Output power	5V:<120W, 12V:<360W , 24V:<576W

Instruction for Job for Both Controller

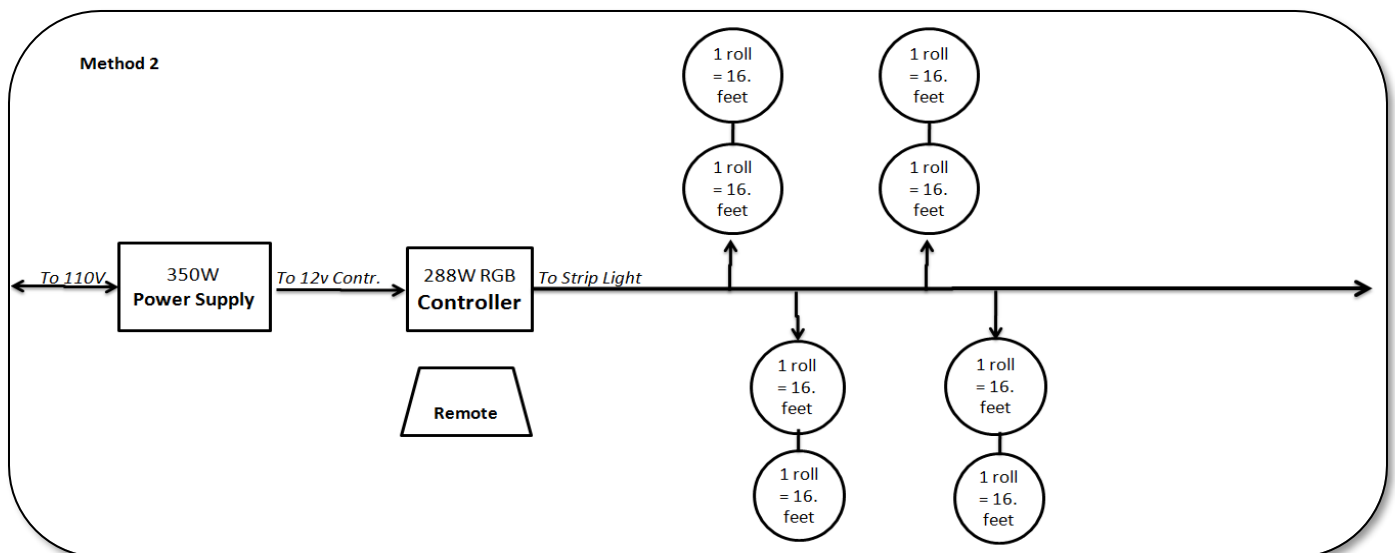

12V Single Color Strip Instruction Way

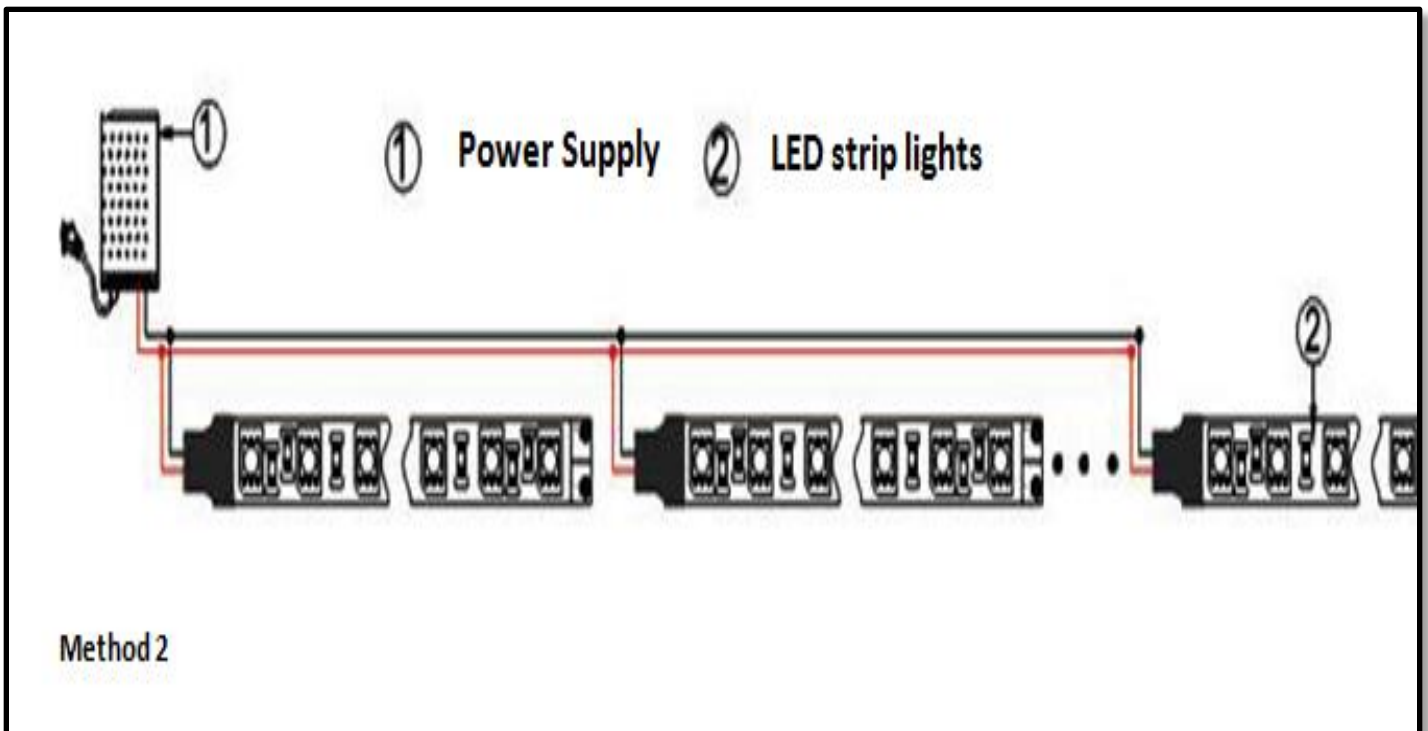
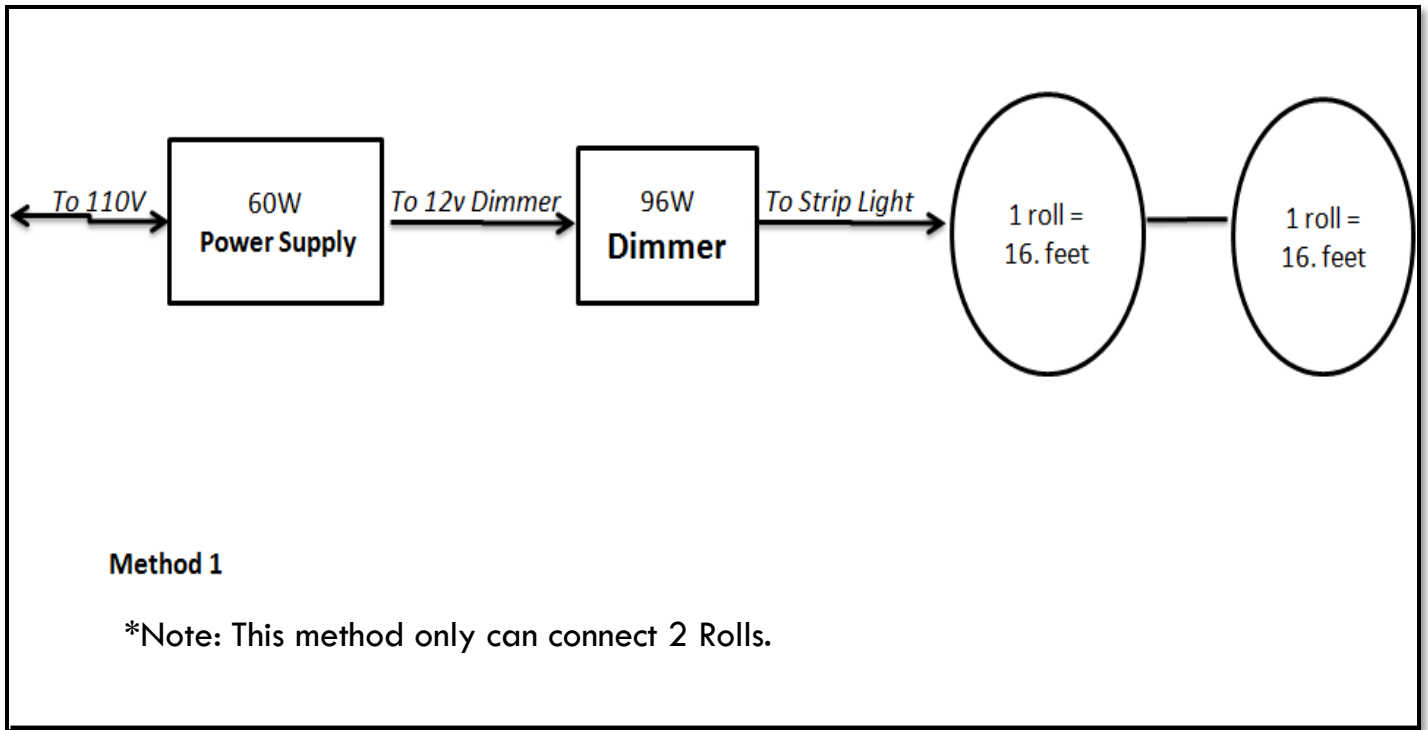

12V H - Single Color Strip



***H: High Level**

2700K

3000K

3500K

4500K

5500K

Item # WS0024

Item # WS0020

Item # WS0021

Item # WS0022

Item # WS0023

*** 12V * 36W/Roll * 4 pin Male/Female ***

Parts Included



- **15" connector 1 pc**
- **20 pcs of clip**
- **2 pcs of black rubber cover**

Accessories for H-Single Color

Directly Connect These Accessories To The Rolls

Item # WS0121

12" Wire Connector 4 Pin



❖ Use for single & RGB

Item # WS0120

Cross Connector 4 Pin

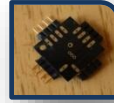

❖ Use for single & RGB

Item # WS0096

N4 T Connector



❖ Use for single & RGB

Item # WS0097

N4 L Connector



❖ Use for single & RGB

Item # WS0098

N4 Cross Connector

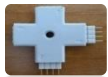

❖ Use for single & RGB

Item # WS0099

N4 Middle Connector



❖ Use for single & RGB

Accessories To Use After Custom Cuts Are Made

Item # WS0124

M4-Connect Box



❖ Middle Connector
❖ 4 clip

Item # WS0125

H4-Connector 6"



❖ Head Connector
❖ 4 clip & 4 wire

Item # WS0126

M4-Connector 6"



❖ 4 clip

Item # WS 0129

L Connector



Item # WS 0130

T Connector



Item # WS 0131

Cross Connector



Other Accessories

Item # WS0127

15" Connector



❖ DC & 4Pin Head

Item # WS0128

T Connector 4 Pin



❖ DC & 4Pin Head (Male & Female)

Item # WS 0132B

U Holder



❖ 1 Meter long
❖ Clear Plastic

Item # WS0133

4 Wire Line



Sell by feet

Item # WS 0132A

Al Holder



❖ 1 Meter long
❖ Aluminum Base & Clear Cover

Item # WS 0132C

U Holder

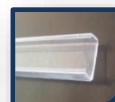

❖ 1 Meter long
❖ Clear Plastic

12V M – Single Color 300 /Roll



- 300 pcs 5050 LED chip/roll
- 12V
- 16.4Ft./Roll
- DC head male/female
- 48 W /Roll

<p><u>3000K</u> use 300 pcs 5050 LED chip/ roll</p>	<p>None Waterproof Item# WS 0043</p>	<p>Waterproof Item# WS 0043W</p>
<p><u>5500K</u> use 300 pcs 5050 LED chip/ roll</p>	<p>None Waterproof Item# WS 0044</p>	<p>Waterproof Item# WS 0044W</p>
<p><u>Green</u> use 300 pcs 5050 LED chip/ roll</p>	<p>Waterproof Item# WS 0065</p>	
<p><u>Blue</u> use 300 pcs 5050 LED chip/ roll</p>	<p>Waterproof Item# WS 0066</p>	
<p><u>Red</u> use 300 pcs 5050 LED chip/ roll</p>	<p>Waterproof Item# WS 0067</p>	
<p><u>Yellow</u> use 300 pcs 5050 LED chip/ roll</p>	<p>Non Waterproof Item# WS 0068</p>	

Item # WS0116
N2 T Connector



Item # WS0117
N2 L Connector

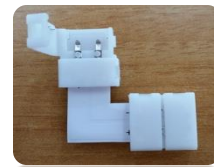

Item # WS0118
N2 Cross Connector

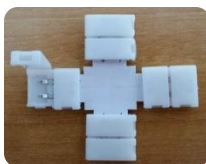

Item # WS0109
N2 Connector 6"



Item # WS0119
N2 Connect Box



Accessories' details on P. 11

ACCESSORIES for M-SINGLE COLOR

Use for 600 pcs LED chip

Use for 300 pcs LED chip

Item # WS0114

3DC Power Feet



❖ Use for M-Single color strip lights

Item # WS0115

1DC Power Feet



❖ Use for M-Single color strip lights

Item # WS0110

M2 Connect Box



❖ Middle Connector
❖ 2 clip

Item # WS0112

H2 Connector 6"



❖ With DC Head
❖ 2 clip & 2 wire

Item # WS0111

M2 connector 6"



❖ 2 clip

Item # WS0116

N2 T Connector

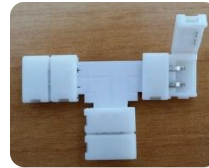

❖ Middle Connector
❖ 2 clip

Item # WS0117

N2 L Connector

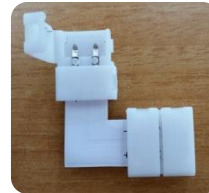

❖ Middle Connector
❖ 2 clip

Item # WS0118

N2 Cross Connector

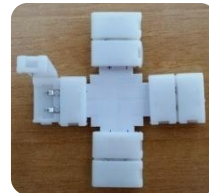

❖ Middle Connector
❖ 2 clip

Item # WS0119

N2 Connect Box



❖ Middle Connector
❖ 2 clip

Item # WS0109

N2 Connector w/ DC



❖ With DC Head
❖ 2 clip

Item # WS0108

N2 Connector 6"



❖ 2 clip

DIMMER for SINGLE COLOR

Item # WS0182 Mini Dimmer w/ Remote



- Power: 144W
- Input: DC5-24V
- Output: 12A

Item # WS0180 Dimmer Set



- Power: 96W
- Input: DC12-24V
- Output: 8A

Item # WS0181 Dimmer for Wall w/ Remote



- Power: 72W
- Size: L3 3/8" x W3 3/8" x H1 5/8"
- Supply: DC12-24v, Current: 6A

H - CHASING STRIP LIGHT



Waterproof

Item # WS0002

- **114 Modes of Chasing Color Change**
- **Use 150pcs 5050LED Chip / Roll, 5 Pin Male/Female**
- **16.40 feet / Roll, DC 12v, 36 w / Roll**

Parts Included



- **25 pcs of clip**
- **2 pcs of pin**
- **2 pcs of black rubber cover**

H-CHASING ACCESSORIES

Item # WS0164

Chasing Controller



- ❖ Effect Mode= 114 modes of chasing color change
- ❖ Input/Output: DC12v only
- ❖ Current: <60MA
- ❖ Use for **High Level Chasing Strip**

Item # WS0100

T Connector 5 Pin



- ❖ Power Supply Connect
- ❖ Pin Connect
- ❖ Use for High Level Chasing

Item # WS0101

12" Wire Connector 5 Pin



- ❖ Use for High Level Chasing

Item # WS0102

Cross Connector 5 Pin

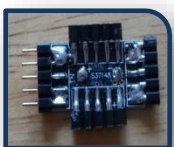

- ❖ Use for High Level Chasing

TRANSFORMERS OUTPUT 12V

150W IP20 POWER SUPPLY (INDOOR)

Item # WS 150WIP20



- Input: AC 110-260V
- Output: DC 12V 12.5A

150W IP65 POWER SUPPLY (OUTDOOR)

Item # WS 150WIP65



- Input: AC 110-260V
- Output: DC 12V 12.5A

250W IP20 POWER SUPPLY (INDOOR)

Item # WS 0143



- Input: AC 110-260V
- Output: DC 12V 20A

250W IP65 POWER SUPPLY (OUTDOOR)

Item # WS 250WIP65



- Input: AC 110-260V
- Output: DC 12V 20A

350W IP20 POWER SUPPLY (INDOOR)

Item # WS 0144



- Input: AC 110-220V
- Output: DC 12V 29A

TRANSFORMERS OUTPUT 12V

24W POWER SUPPLY (INDOOR)

Item # WS 0140



- Input: AC100-240V
- Output: DC 12V 2A

60W POWER SUPPLY (INDOOR)

Item # WS 0141



- Input: AC100-240V
- Output: DC 12V 5A

60W IP20 POWER SUPPLY (INDOOR)

Item # WS 60WIP20



- Input: AC100-240V
- Output: DC 12V 5A

60W IP65 POWER SUPPLY (OUTDOOR)

Item # WS 60WIP65



- Input: AC100-240V
- Output: DC 12V 5A

96W POWER SUPPLY (INDOOR)

Item # WS 0142



- Input: AC100-240V
- Output: DC 12V 8A

DIMMABLE LED DRIVER OUTPUT 12V



APPROVED

60W POWER SUPPLY (OUTDOOR)

Item # **WS 0146_UL60**



- Input: AC100-277V
- Output: DC 12V
- 12V 5-in-1 Dimmable
- 0-100% Dimming
- Waterproof IP67

Size:
6.6"x3.5"x1.5"

100W POWER SUPPLY (OUTDOOR)

Item # **WS 01416_UL100**



- Input: AC100-277V
- Output: DC 12V
- 12V 5-in-1 Dimmable
- 0-100% Dimming
- Waterproof IP67

Size:
8"x3.5"x1.5"

200W POWER SUPPLY (OUTDOOR)

Item # **WS 146_UL200**



- Input: AC100-240V
- Output: DC 12V
- 12V 5-in-1 Dimmable
- 0-100% Dimming
- Waterproof IP67

Size:
8"x3.5"x1.5"

300W POWER SUPPLY (OUTDOOR)

Item # **WS 146_UL300**



- Input: AC100-240V
- Output: DC 12V
- 12V 5-in-1 Dimmable
- 0-100% Dimming
- Waterproof IP67

Size:
8"x3.5"x1.5"





Light Bulbs

GU10/PAR20 30 light bulbs



- ❖ 110 -130V AC
- ❖ CRI > 80
- ❖ Dimmable
- ❖ 3 years warranty
- ❖ Bean Angle: 38°
- ❖ Replacement: 75W



Item#	Description	Watt	Temp. Color	Lumen	hours	Feature	
	WB 6330	GU10 3000K	8W	3000K	500	25000	Dim
	WB 6350	GU10 5000K	8W	5000K	500	25000	Dim
	WB 7387WW	PAR20 3000K	8W	3000K	500	25000	Dim
	WB 7387DL	PAR20 5000K	8W	5000K	500	25000	Dim
	WB 7388WW	PAR30 short neck 3000K	10W	3000K	800	25000	Dim
	WB 7388DL	PAR30 short neck 5000K	10W	5000K	800	25000	Dim
	WB 7370WW	PAR38	16W	3000K	1300		Dim

LIGHT BULBS



GU10 9W 2700K

Item# WB8327

- ⇒ 9W
- ⇒ 120V, 60HZ 600 Lumens
- ⇒ CRI>90
- ⇒ 38 Degree
- ⇒ Dimmable



GU10 9W 3000K

Item# WB8330

- ⇒ 9W
- ⇒ 120V, 60HZ 600 Lumens
- ⇒ CRI>90
- ⇒ 38 Degree
- ⇒ Dimmable



GU10 9W 5000K

Item# WB8350

- ⇒ 9W
- ⇒ 120V, 60HZ 600 Lumens
- ⇒ CRI:>90
- ⇒ 38 Degree
- ⇒ Dimmable

LIGHT BULBS

Middle Level Bulbs



8MR16/DL

Item# WB7102

- ⇒ 12V, Daylight, 470Lumens
- ⇒ Bi-Pin GU5.3, 38 Degree, Dimmable for Magnet!
- ⇒ 8 Watts



7E26/DL

Item# WB7305

- ⇒ 120V, Daylight, 360Lumens
- ⇒ 38 Degree, Dimmable !
- ⇒ 7 Watts

L.E.D 12V MR16 LIGHT **UL APPROVE**

MR16



WB 8103

UL MR16 9W Warm White

- ⇒ Color Temp.: 2700K
- ⇒ Beam Angle: 38°
- ⇒ 800 Lumen, Dimmable!
- ⇒ Citizen LED Chip

L.E.D LIGHT



High Level Bulbs

Par 20



WB 7325 CL, 10W 4000K 650 Lumens Dimmable !

Par 30



WB 7326 WW, 17W 3000K 1100 Lumens Dimmable !

WB 7326 CL, 17W 4000K 1100 Lumens Dimmable !

Par 38



WB 7327 WW, 24W 3000K 1600 Lumens Dimmable !



WB 7329 WW

BR30 2700K 17W 1100 Lumens, Dimmable!

WB 7329 DL

BR30 5000K 17W 1100 Lumens, Dimmable!



WB 7330 WW

BR40 2700K 25W 1600 Lumens, Dimmable!

OUTDOOR FLOOD LIGHT

20W RGB w / REMOTE

Item # WO RGB20



- ❑ LED type: COB
- ❑ Power :20W
- ❑ Dimension:4.5"x3.5"x4"
- ❑ Input (V): 85~265V AC
- ❑ Lifespan: ≥50,000H
- ❑ Material: Aluminum
- ❑ IP grade: IP65
- ❑ Warranty: 5 years

30W (DAYLIGHT)

Item # WO 4130



- ❑ Power: 30W
- ❑ Voltage: AC90-260V
- ❑ Luminous Flux: >1400lm
- ❑ Beam Angle: 120 Degrees
- ❑ Color Temp: Daylight
 - ❑ 6000-5000K
- ❑ Dimension: 7"x5.5"x4.5"
- ❑ Material: Aluminum
- ❑ Life Span: 50,000 hrs
- ❑ IP Grade: IP65

20W PIR MOTION SENSOR (DAYLIGHT)

Item # WO 4120M



- ❑ LED type: COB
- ❑ Power :20W
- ❑ Size:4.5"x6.5"x4"
- ❑ Input (V): 85~265V AC
- ❑ Lifespan: ≥50,000H
- ❑ Material: Aluminum
- ❑ IP grade : IP54;IP65
- ❑ Warranty:5 years

30W PIR MOTION SENSOR (DAYLIGHT)

Item # WO 4130M



- ❑ 200W Replacement
- ❑ Water-proof
- ❑ Color Temp: 6000-5000K
- ❑ Dimension: 7"x7.5"x4.5"
- ❑ Input:AC85-285V
- ❑ Angle: 120 Degrees
- ❑ Life Span: 50,000 hrs

OUTDOOR FLOOD LIGHT

50W (DAYLIGHT)

Item # WO 4150



- Power :50W
- Dimension: 24.6*19*4.2cm
- Voltage: AC85-265V
- Luminous Flux: $\geq 110\text{Lm/W}$
- Material: Aluminum
- Color Temp: Daylight
- IP grade : IP65

50W RGB w / REMOTE

Item # WO RGB50



- LED type: COB
- Power :50W
- Dimension: 11''x9''x5.5''
- Input (V): 90~260V AC
- Lumens: 0 - 3850 lm
- Material: Aluminum
- IP grade: IP65

100W

Item # WO 4100 & WO 4140



- Power: 100W
- Voltage: AC90-260V
- Luminous Flux: $> 8400\text{ lm}$
- Color Temp: 4000k&6000k
- Dimension: 14''x10''x3.5''
- Material: Aluminum
- IP Grade: IP65

200W

Item # WO 4300 & WO 4340



- Power: 200W
- Voltage: AC85-265V
- Luminous Flux: $\geq 110\text{Lm/W}$
- Color Temp: 4000k&6000k
- Dimension: 46.1*30.3*4.9cm
- Material: Aluminum
- IP Grade: IP65

T5 LED TUBE



Item No	WT 5301	WT 5501	WT 5302	WT 5502	WT 5303	WT 5503	WT 5304	WT 5504
Length	1 Ft.	1 Ft.	2 Ft.	2 Ft.	3 Ft.	3 Ft.	4 Ft.	4 Ft.
Color Temp.	2700K	5500K	2700K	5500K	2700K	5500K	2700K	5500K
Power (W)	5W	5W	10W	10W	13W	13W	20W	20W
Luminous	450±8%	450±8%	900±8%	900±8%	1000±8%	1000±8%	1700±8%	1700±8%

T5 ACCESSORIES

Item No.	Description
WT 5001	4 Feet Power Cord
WT 5002	12 Inch Middle Connector



INSTALLATION

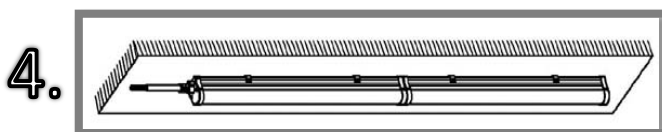
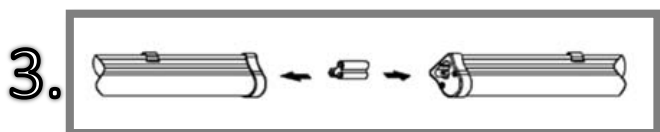
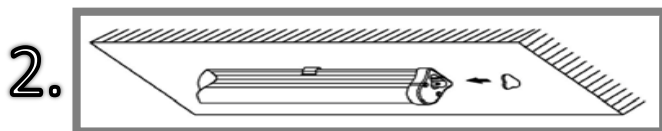
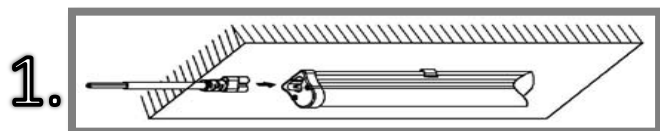

T8 LED TUBE



5 CCT & 5 Wattage Tunable



Description:

- *Universal Type A+B*
- *With & Without Ballast*
- *Life Time: 50000H+Lifetime*
- *Operating Temp: -4F Degree To 113F Degree*

Item No	Length	Color Temp.	Cover	Power(W)	Input
WT 8904	4 Ft.	3000/4000/5000/ 5500/6000K CCT	Clear	10w/12w/15w/ 18w/22w Tunable	AC120- 277v 50/60HZ
WT 8914	4 Ft.	3000/4000/5000/ 5500/6000K CCT	Frost	10w/12w/15w/ 18w/22w Tunable	AC120- 277v 50/60HZ

T8 LED TUBE



5 CCT & 5 Wattage Tunable



Description:

- *Universal Type A+B*
- *With & Without Ballast*
- *Life Time:
50000H+Lifetime*
- *Operating Temp. -4F Degree
To 113F Degree*

Item No	Length	Color Temp.	Cover	Power(W)	Input
WT 8908	8 Ft.	3000/4000/5000/ 5500K/6000K CCT	Clear	24w/28w/32w /36w/40w Tunable	AC120- 277v, 50/60HZ
WT 8918	8 Ft.	3000/4000/5000/ 5500/6000K	Frost	24w/28w/32w /36w/40w Tunable	AC120- 277v, 50/60HZ

T8 LED TUBE



Type A + B W/O ballasts !

Clear Cover

Item No	WT 4F18W5KC	WT 8302	WT 8502
Length	4 Ft.	2 Ft.	2Ft.
Color Temp.	5000K	3000K	60000k
Power (W)	18W	9W	9W
Lumens	>2100lm	AC 85-265	AC85-265



Frost Cover

Item No	WT 4F18W5KF	WT 8312	WT 8512
Length	4 Ft.	2 Ft.	2 Ft.
Color Temp.	5000K	3000K	6000k
Power (W)	18W	10W	10W
Lumens	>2100lm	AC 85-265	AC85-265



T8 LED TUBE



No ballast !

Clear Cover



Item No	WT 8508 Type B	WT 8504 Type B	WT 8304 Type A	WT 8404 Type A
Length	8 Ft.	4Ft.	4 Ft.	4 Ft.
Color Temp.	6000K	5000K	3000K	4000K
Power (W)	40W	20W	20W	20W
Put In	AC 85 - 265	AC 85 - 265	AC 85 - 265	AC 85 - 265

Frost Cover



Item No	WT 8108 Type B	WT 8514 Type B	WT 8314 Type A	WT 8414 Type A
Length	8Ft.	4Ft.	4 Ft.	4 Ft.
Color Temp.	6000K	5000K	3000K	4000K
Power (W)	40W	20W	20W	20W
Put In	AC 85 - 265	AC 85 - 265	AC 85 - 265	AC 85 - 265

T8 LED TUBE



Compatible! Dimmable! Both Sides power in !

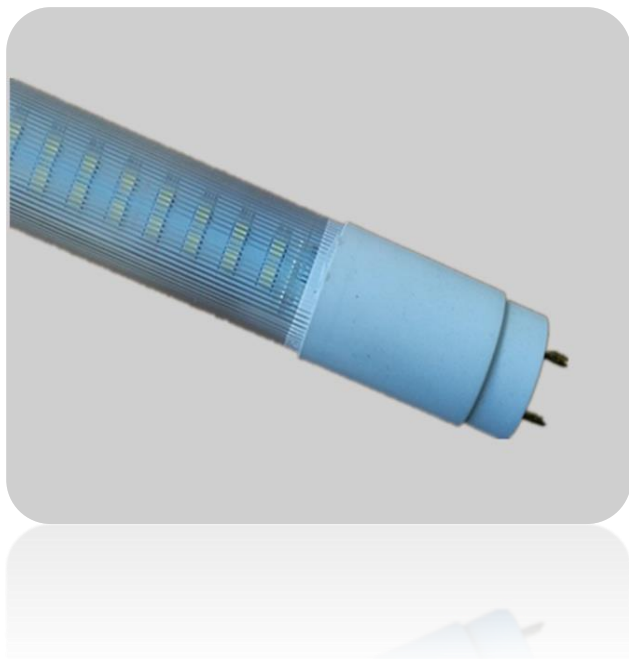

Description:

- Compatible
- Ballast
- Dimmable
- Life Time: 50000H

Item No	Length	Color Temp.	Cover	Power(W)	Input	Lumens
WT 8554	4 Ft.	5000K	Clear	18W	AC 85 - 265	1800
WT 8654	4 Ft.	6500K	Clear	18W	AC 85 - 265	1800

T8 Fixture & Accessory

ITEM NO.: WT 8012

- 2 ft. T8 use
- Dimension: 24.5"x1.5"x1"



ITEM NO.: WT 8022

- 2 ft. T8 use
- Dimension: 24.5"x3"x1.5"



ITEM NO.: WT 8014

- 4 ft. T8 use (**UL Approved**)
- Dimension: 48.5"x1.5"x1"

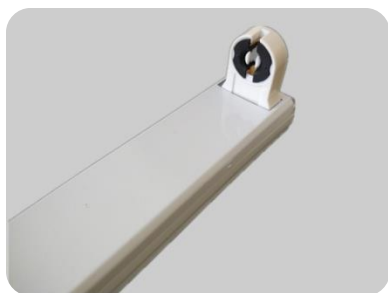

ITEM NO.: WT 8024

- 4 ft. T8 use (**UL Approved**)
- Dimension: 48.5"x3"x1.5"



ITEM NO.: WT 8018

- 8 ft. T8 use (**UL Approved**)
- Single Tube
- Dimension: 96.5"x2.0"x1.6"



ITEM NO.: WT 8028

- 8 ft. T8 use (**UL Approved**)
- Double Tube
- Dimension: 96.5"x3.3"x1.6"



Integrate V - T8

Use for AC 100V - 277V



• WT 8802 2FT. 18W 6000K 96Pcs
SMD2853, Alum.+PC

• WT 8804 4FT. 30W 6000K 192Pcs
SMD2853, Alum.+PC

• WT 8806 6FT. 40W 6000K 288Pcs
SMD2853, Alum.+PC

• WT 8808 8FT. 60W 6000K 384Pcs
SMD2853, Alum.+PC

Extra Parts

WT 5002 12" Middle Connector

WT 5001 5FT. Power Cord w/
Switch



3"4" LED Adjust Gimbal Light



Item No. : WR 8000

- Gyre head
- Dimmable
- 120VAC 50/60Hz
- Wattage: 8W 960 Luminous
- 3000K/4000K/5000K CCT changeable
- 24° Beam Angle



Adjust Trim



Item No. : WR 803
3" white trim



Item No. : WR 804
4" white trim

LED DESK LAMP

Item # WD 290

White

w/o USB Port



- ✓ **Power:** 12W
- ✓ **Input:** DC12V
- ✓ **Adjustable Color**
Temperature: 3000K~6000K
- ✓ **Desk Lamp Size:**
41*18*20*44cm
- ✓ **Beam Angle:** 140 degree
- ✓ **Long Lifespan:** 50,000h
- ✓ **Warranty:** 2 years
- ✓ **Dimmable:** Stepless
- ✓ **Safe To Touch**
- ✓ **No Radiation ! No Ultraviolet**
! No Flash !