

*Wei's - l.e.d*®

# *2026 Catalog*

**Wei's International Trading Corp**

**347-268-6865 , 718-815-5600**

**[weisled@msn.com](mailto:weisled@msn.com)**

# 10-60 Degree Beam Adjustable LED Track Head

**NEW**



Product Information	
Item No.	WG 652B (black) & WG 652W (white)
Wattage	20W
Input Voltage	AC120v 60Hz
Track Adapter	H-type
5CCT Adjustable	27/30/35/40/50K
CRI	CRI95
Beam Angle	10-60 Degree Bean Adjustable
Size	W2.95"x L 6.22"x H6.1"
Dimming	Triac Dimming 100%-10%
Lumens	2500Lm. Maximum
Projected Life	50000Hrs
Rotation	355 Degree Horizontal
Tile	90 Degree Vertical
Certification	ETL,UL

Technical Drawing:

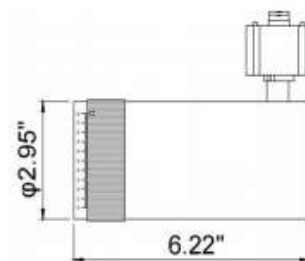
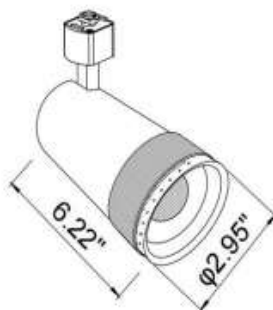

# 3 COLOR IN 1 TRACK LIGHTING



Item No:

**WG 532B & WG 532W**

Wattage: 20W Black & White

CCT: 3000K/4000K/5000K

16 Pcs/cs

Item No:

**WG 531B & WG 531W**

Wattage: 10W Black & White

CCT: 3000K/4000K/5000K

20 Pcs/cs

B: Black W: White

- ❖ *3 CCT changeable : 3000k /4000k /5000k*
- ❖ *38 ° Angle*
- ❖ *Dimmable !*
- ❖ *CRI > 90*
- ❖ *Input: 120V / 50-60 Hz*
- ❖ *Chip Brand: Bridgelux LED*
- ❖ *Warranty: 3 Years*

# LED Track Light 5CCT Changeable



■ BLACK

□ WHITE

❖ *5 CCT changeable*

❖ *38° Angle*

❖ *Dimmable*

❖ *CRI > 90*

❖ *1000 Lumens*

❖ *Input: 120V / 50-60 Hz*

❖ *Warranty: 30000 hours*

**5CCT changeable:**  
2000K/3000K/4000K  
/5000K/6000K

*Item No.*

***WG 551B & WG 551W***

***10W Black & White***

***Size: 2.95"x 2.36"x 5.1"***

***50Pcs/cs***

# LED Track Light 3CCT Changeable



■ BLACK

□ WHITE

- ❖ *3CCT changeable : 3000k /4000k /5000k*
- ❖ *38 ° Angle*
- ❖ *Dimmable !*
- ❖ *CRI > 80*
- ❖ *Input: 120V / 50-60 Hz*
- ❖ *Chip Brand: Bridgelux LED*
- ❖ *Warranty: 4 Year*

*Item No.*

**WG 312W**

12W White

Size: L 4.75"x W 2.4"x H 6.3"

**50 pcs/cs**

*Item No.*

**WG 325W**

25W White

Size: L 5.1"x W 3.1"x H 7.1"

**20 pcs/cs**

# LED Track Light Single Color



- BLACK □WHITE
- ❖24° Angle
- ❖W/ 38° lens
- ❖Lumens: 789
- ❖20 Pcs/cs

WG 105B  
WG 105W  
**10W 5000K**



- BLACK
- ❖38° Angle
- ❖W/ 24° lens
- ❖Lumens: 1315
- ❖10 Pcs/cs

WG 155B  
**15W 5000K**

AC 120V / 24° & 38° BEAM/  
DIMMABLE



- BLACK □WHITE
- ❖38° Angle
- ❖W/ 24° lens
- ❖Lumens: 3295
- ❖8 Pcs/cs

WG 353W  
**35W 3000K**

WG 355B  
WG 355W  
**35W 5000K**



# LED Track Light Single Color



■ BLACK

□ WHITE

- ❖ *36° Angle*
- ❖ *Dimmable*
- ❖ *CRI > 80*
- ❖ *Light Efficiency: 80 Lums/W*
- ❖ *Track Head: Hallo*
- ❖ *Input: 120V / 50-60 Hz*
- ❖ *Chip Brand: Philips*
- ❖ *Warranty: 3 years*

Exchange Lens  
15° -25°  
Angle



WG 012 /12W  
WG 025 /25W

## Item No.

**WG 1123W**  
12W 3000K  
20 Pcs/cs

**WG 1125B & WG 1125W**  
12W 5000K  
20 Pcs/cs

**WG 1255B & WG 1255W**  
25W 5000K  
10 Pcs/cs

**12w Size: 6"x 2.5"x 6.2"    25w Size: 7.2"x 3.1"x 6.6"**  
**(B=Black, W=White)**

# GU 10 TRACK LIGHT FIXTURE



Not include GU10 Light Blub !



B: Black or W: White

- ❖ Item No. **WG 87B & 87W**
- ❖ Watt: **GU10/ Max 60W**
- ❖ Voltage: **120V / 50-60 Hz**
- ❖ **24 Pcs/cs**

- ❖ Item No. **WG 86B & 86W**
- ❖ Watt: **GU10/ Max 60W**
- ❖ Voltage: **120V / 50-60 H**
- ❖ **24 Pcs/cs**

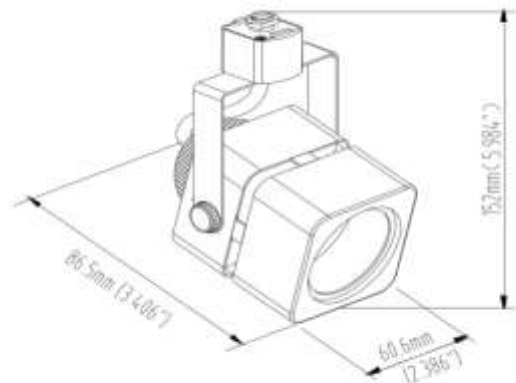
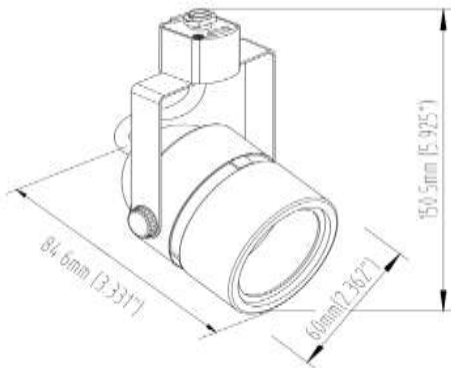

# GU 10 TRACK LIGHT FIXTURE



■BLACK

□WHITE

- ❖ Item No. **WG 85B**
- ❖ Watt: **GU10/ Max 50W**
- ❖ Voltage: **120V / 50-60 Hz**
- ❖ **60 Pcs/cs**

- ❖ Item No. **WG 85W**
- ❖ Watt: **GU10/ Max 50W**
- ❖ Voltage: **120V / 50-60 H**
- ❖ **60Pcs/cs**

*Measurement: "mm"*

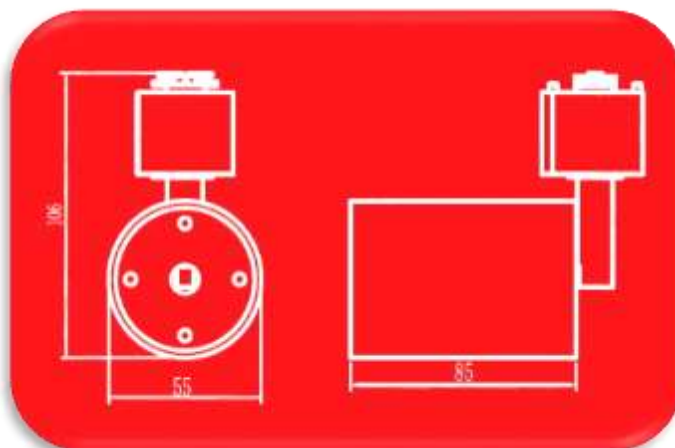

**Not include GU10 Light Blub !**

# MR 16 TRACK LIGHT FIXTURE



Not include MR16 Light Blub !



WHITE &  BLACK

- ❖ Item No. **WG42 W or B**
- ❖ Watt: **MR 16/ Max 60W**
- ❖ Output : **Voltage: 12V**



WHITE

- ❖ Item No. **WG120**
- ❖ Watt: **MR16/ Max 60W**
- ❖ Output : **Voltage: 12V**



BLACK

- ❖ Item No. **WG371**
- ❖ Watt: **MR 16/ Max 60W**
- ❖ Output : **Voltage: 12V**



BLACK

- ❖ Item No. **WG123**
- ❖ Watt: **MR 16/ Max 60W**
- ❖ Output : **Voltage: 12V**

# 3CCT GU10 8W 500LM CRI: 85

Item: WB 8603

**NEW**



Item Information	
Item No.	WB 8603
Wattage	8w
Primary Replacement	75w
Color Temperature	3cct : 30/40/50k
Lumens	500
Base Cap	GU 10
Size : W X H	1.93" X2.3"
Life Time	25000hrs
Dimmable (Y/N)	Yes
Operating Temperature	-20/45°C
Warranty	3 Years
Environmental(RoHS/REACH)	RoHS
Certificate	UL/CUL

## *Dimension*



# 5CCT PAR 20 8W 500LM CRI: 85

Item: WB 7507

**NEW**



Item Information	
Item No.	WB 7507
Wattage	8w
Primary Replacement	75w
Color Temperature	5cct : 27/30/35/40/50k
Lumens	500
Base Cap	E 26
Lamp Type	Par 20
Size : W X H	2.4" X3.1"
Life Time	25000hrs
Dimmable (Y/N)	Yes
Operating Temperature	-20/45°C
Warranty	3 Years
Environmental(RoHS/REACH)	RoHS
Certificate	UL/CUL

*Dimension :*



# High Power LED Bulbs



## GU10/ MR 16 LED Bulbs

- ❖ 12 -130V AC
- ❖ CRI > 85
- ❖ Dimmable
- ❖ 3 years warranty
- ❖ Beam Angle:  $\geq 38^\circ$
- ❖  $\geq 800$  Lumens



Item#	Description	Watt	Output	Lumen	Hours	Feature
-------	-------------	------	--------	-------	-------	---------



WB 8527

GU10 2700K

8W

110V

800

25000

Dim

WB 8550

GU10 5000K

8W

110V

800

25000

Dim

50 pcs/cs



WB 8127

MR 16 2700K

8W

12V

800

25000

Dim

WB 8150

MR 16 5000K

8W

12V

800

25000

Dim

50 pcs/cs



# Light Bulbs



## PAR. Light Bulbs

- ❖ 110 -130V AC
- ❖ CRI > 80
- ❖ Dimmable
- ❖ 3 years warranty
- ❖ Beam Angle:  $\geq 38^\circ$
- ❖ Replacement: 75W



Item#	Description	Watt	Temp. Color	Lumen	hours	Feature
-------	-------------	------	-------------	-------	-------	---------



WB 7387WW	PAR20 3000K	8W	3000K	500	25000	Dim
WB 7387DL	PAR20 5000K	8W	5000K	500	25000	Dim

50 pcs/cs



WB 7388WW	PAR30 short neck 3000K	10W	3000K	800	25000	Dim
WB 7388DL	PAR30 short neck 5000K	10W	5000K	800	25000	Dim

50 pcs/cs



WB 7370WW	PAR38 3000K	16W	3000K	1300	25000	Dim
-----------	-------------	-----	-------	------	-------	-----

12 pcs/cs

# High Level Bulbs

APPROVE



## Par 20

**WB 7325 CL,** 10W 4000K 650 Lumens Dimmable !

24 pcs/cs



## Par 30

**WB 7326 WW,** 17W 3000K 1100 Lumens Dimmable !

**WB 7326 CL,** 17W 4000K 1100 Lumens Dimmable !

18 pcs/cs



**WB 7329 WW**

**BR30 2700K** 17W 1100 Lumens, Dimmable!

**WB 7329 DL**

**BR30 5000K** 17W 1100 Lumens, Dimmable!

20 pcs/cs



**WB 7330 WW**

**BR40 2700K** 25W 1600 Lumens, Dimmable!

12 pcs/cs

# MR 16 , GU10



**100 pcs/cs**

**8MR16/DL**

*Item# WB7102*

- ⇒ 12V, Daylight, 470Lumens
- ⇒ Bi-Pin GU5.3, 38 Degree, Dimmable for Magnet!
- ⇒ 8 Watts



*Item# WB7305*

**7E26/DL**

- ⇒ 120V, Daylight, 360Lumens
- ⇒ 38 Degree, Dimmable !
- ⇒ 7 Watts

# Fixture for T8 Tube Light



## ITEM NO.: WT 8012

- 2 ft. Single
- Dimension: 24.5"x1.5"x1"
- 15 pcs/cs



## ITEM NO.: WT 8022

- 2 ft. Double
- Dimension: 24.5"x3"x1.5"
- 8 pcs/cs



## ITEM NO.: WT 8014

- 4 ft. Single
- Dimension: 48.5"x1.5"x1"
- 15 pcs/cs



## ITEM NO.: WT 8024 *New*

- 4 ft. Double
- Heavy Duty
- Dimension: 48.5"x1.5"x1.5"
- 10 pcs/cs



## ITEM NO.: WT 8018

- 8 ft. Single
- Dimension: 96.5"x2.0"x1.6"
- 6 pcs/cs



## ITEM NO.: WT 8028 *New*

- 8 ft. Double
- Heavy Duty
- Dimension: 96.5"x3.3"x1.6"
- 6 pcs/cs



# T8 LED TUBE



## 5 CCT & 5 Wattage Tunable



### Description:

- Universal Type A+B
- With & Without Ballast
- Life Time: 50000H+Lifetime
- Operating Temp: -4F Degree To 113F Degree
- **25 pcs/cs**

Item No	Length	Color Temp.	Cover	Power(W)	Input
<b>WT 8914 8904</b>	4 Ft.	3000/4000/5000/5700 /6500K CCT	Frost & Clear	10w/12w/15w/18 w/24w Tunable	AC120- 277v 50/60HZ
<b>WT 8918 8908</b>	8 Ft.	3000/4000/5000/5700 /6500K CCT	Frost & Clear	24w/30w/50w/60 w/72w Tunable	AC120- 277v 50/60HZ

## Type A + B 5000K

25 pcs/cs

Item No	WT 4F18W5KF Flost	WT 8302 Clear	WT 8312 Flost	WT 8512 Clear	WT 8512 Flost
Length	4 Ft.	2 Ft.	2 Ft.	2 Ft.	2 Ft.
Color Temp.	5000K	3000K	3000K	6000k	6000k
Power (W)	15W	10W	10W	10W	10W
Lumens	>2100lm	AC 85-265	AC 85-265	AC85-265	AC85-265

# T8 LED TUBE



**No ballast !**

## Clear Cover



Item No	WT 8304 Type A	WT 8404 Type A
Length	4 Ft.	4 Ft.
Color Temp.	3000K	4000K
Power (W)	20W	20W
Put In	AC 85 - 265	AC 85 - 265

## Frost Cover



Item No	WT 8314 Type A	WT 8414 Type A
Length	4 Ft.	4 Ft.
Color Temp.	3000K	4000K
Power (W)	20W	20W
Put In	AC 85 - 265	AC 85 - 265

**25 pcs/cs**

# T8 LED TUBE

APPROVE



**Compatible! Dimmable! Both Sides power in !**

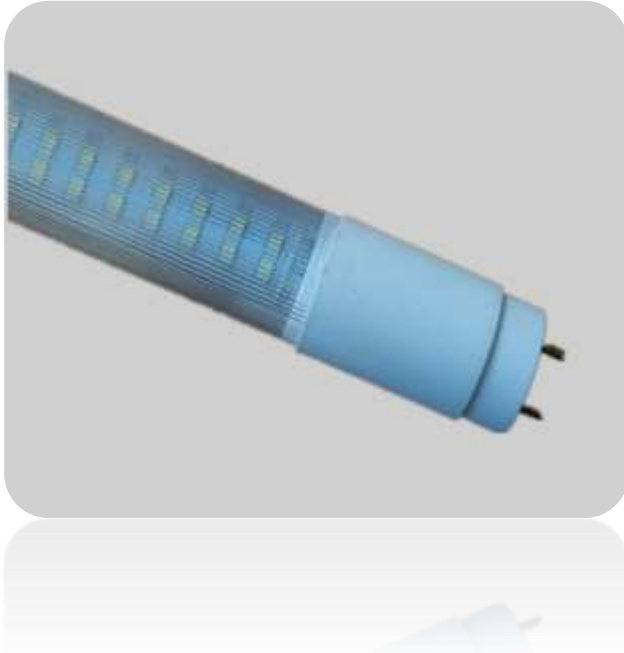

### Description:

- Compatible
- Ballast
- Dimmable
- Life Time: 50000H
- 25 pcs/cs

Item No	Length	Color Temp.	Cover	Power(W)	Input	Lumens
WT 8554	4 Ft.	5000K	Clear	18W	AC 85 - 265	1800
WT 8654	4 Ft.	6500K	Clear	18W	AC 85 - 265	1800

# Integrate V - T8

*Use for AC 100V - 277V*



- **WT 8802 2FT.**
- 18W 6000K 96Pcs of SMD2853
- Alum.+PC **20 pcs/cs**

- **WT 8804 4FT.**
- 30W 6000K 192Pcs SMD2853
- Alum.+PC **20 pcs/cs**

**WT 5002** 12" Middle Connector



**WT 5001** 5FT. Power Cord w/ Switch



# T5 LED TUBE



Item No	WT 5301	WT 5501	WT 5302	WT 5502	WT 5303	WT 5503	WT 5304	WT 5504
Size	1 Ft.	1 Ft.	2 Ft.	2 Ft.	3 Ft.	3 Ft.	4 Ft.	4 Ft.
Color Temp.	2700K	5500K	2700K	5500K	2700K	5500K	2700K	5500K
Power (W)	5W	5W	10W	10W	13W	13W	20W	20W
Lum.	450±8 %	450±8 %	900±8 %	900±8 %	1000 ± 8%	1000 ± 8%	1700 ± 8%	1700 ± 8%

## T5 ACCESSORIES

Item No.	Description
WT 5001	4 Feet Power Cord
WT 5002	12 Inch Middle Connector



## INSTALLATION

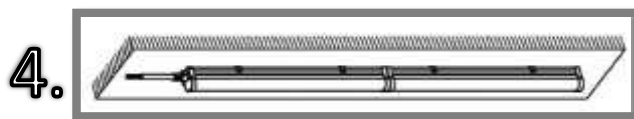
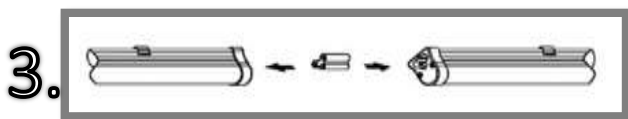
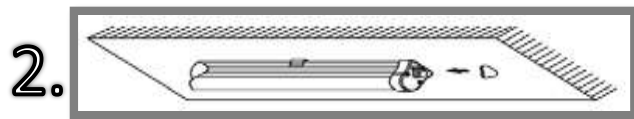
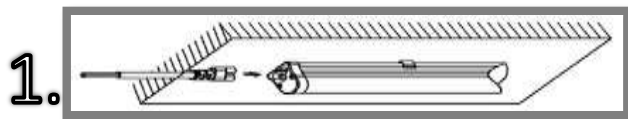

# 3"4" LED Adjust Gimbal Light



## Item No. : WR 8000

- Gyre head
- Dimmable
- 120VAC 50/60Hz
- Wattage: 8W 960 Luminous
- 3000K/4000K/5000K CCT changeable
- 24° Beam Angle



## Adjust Trim



Item No. : WR 803  
3" white trim



Item No. : WR 804  
4" white trim

# Aluminum Channel

*Use For 12V & 110V Strips*

## Item # WS 0132B

- ❖ 1 Meter long = 3.3 Ft.
- ❖ Aluminum Base & Frost Cover



## Item # WS 0132C

- ❖ 8 ft. long
- ❖ Aluminum Base & Frost/Clear Cover
- ❖ **8.5 mm** deep

---

## Item # WS 0132D

- ❖ 8 ft. long
- ❖ Aluminum Base & Frost/Clear Cover
- ❖ **13 mm** deep

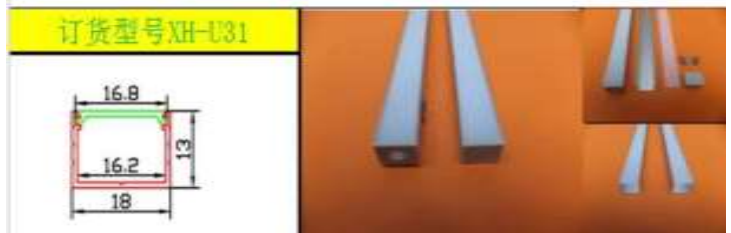

---

## Item # WS 0192

- ❖ 8 ft. long
- ❖ Aluminum Base & Frost/Clear Cover
- ❖ **10 mm** deep

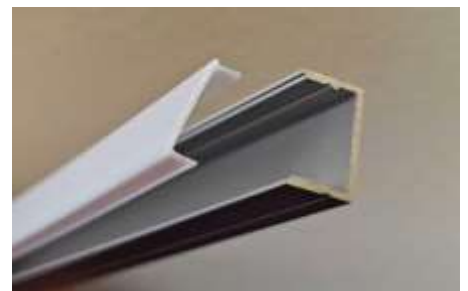

# COB 120V LED STRIP



WS 0036  
**27-30K COB LED Strip**

- 90-130V Strip light
- IP65 Waterproof
- 3.5W Per Foot
- 90 CRI
- 300 Lumens Per Foot
- Cut Points Every 10"
- 50M=165 Ft./roll
- 8mm PVC Cobb Tape
- Temp: -15°C~45°C
- 2 Year Warranty

WS 0037  
**6000K COB LED Strip**

- 90-130V Strip light
- IP65 Waterproof
- 3.5W Per Foot
- 90 CRI
- 300 Lumens Per Foot
- Cut Points Every 10"
- 50M=165 Ft./roll
- 8mm PVC Cobb Tape
- Temp: -15°C~45°C
- 2 Year Warranty

## ACCESSORIES

\*Power Cord\*

\*8 Foot Aluminum Channel

\*Plastic Clip for 120V\*

\*120V End Caps\*

Item # WS0138C



Item # WS0132C



Item # WS0135



Item # WS0136



\*COB 12" Strip Light Middle Connector\*

Item # WS 0137C



# 120V 5050 RGB LED STRIP

## WS 0030

165 ft./ Roll



- 110v RGB Strip Light
- < 9W/ 3.3 Ft.
- 60 led Chips / Meter
- 14-16Lm. per LED Chip
- 19.68 INCHES/cut
- 15mm Wide
- Temp: -30°C-45°C
- 100-130V AC IP67

## WS 0156

## WS 0155



- 110v RGB IR Controller 165ft.
- Input: 100-130V
- Current: 3\*3A
- Power: 750W
- Control 160 Ft.
- 24 Key remote controller

- 110v RGB RF Controller 165ft.
- Input: 100-130V
- Current: 3\*3A
- Power: 800W
- Control 160 Ft.
- 24 Key remote controller



## ACCESSORIES



### *Item # WS0137*

- \* 9" Jump Feet
- \* Use from Power to Strip Only



### *Item # WS0138*

- \* Power Cord

# 120V 5050 Single Color LED STRIP



**WS 0034 (3000K) & WS 0033 (6000K)**

*165 ft./ Roll*



- 165 ft./ Roll
- 6W / 3.3 Ft.
- 60 led Chips / Meter
- 20-22Lm per LED Chip
- 1 meter/cut
- 15mm Wide
- Temp: -30°c-45°c
- 100-130VAC IP67

## ACCESSORIE



*Item # WS0137S*

\*Middle Jump feet from Strip to Strip, 12" Length

## ACCESSORIES

*Item # WS0138S*

*Power Cord*



®

# Switchable & Dimmable driver

## 12v/24v



### 60W

Item # WP 0060



- Input: 120-277Vac 50/60 Hz
- Output: 12v5A-24v2.5A
- Prated: 60W Max
- Suitable for Dry, Damp and Wet Locations
- **25 pcs/CS**

Size:  
**6.3"x2.9"x1.3"**

### 100W

Item # WP 0100



- Input: 120-277Vac 50/60Hz
- Output: 12v 8.33A-24v 4.15a
- Prated: 100W Max
- Suitable for Dry, Damp and Wet Locations
- **20 pcs/CS**

Size:  
**6.5"x3.6"x1.5"**

### 200W

Item # WP 0200



- Input: 120-277Vac 50/60Hz
- Output: 12v 16.5A-24v -8.26a
- Prated: 200W Max
- Suitable for Dry, Damp and Wet Locations
- **5 pcs/CS**

Size:  
**8.2"x3.7"x1.5"**

### 300W

Item # WP 0300



- Input: 120-277Vac 50/60Hz
- Output: 12v 25A-24v -12.5A
- Prated: 300W Max
- Suitable for Dry, Damp and Wet Locations
- **5 pcs/CS**

Size:  
**10.2"x5.2"x1.7"**

# Dimmable Led Driver Output 12V



**APPROVED**

**200W**

*Item # WS 146\_UL200*



- Input: AC100-240V
- Output: DC 12V
- 12V 5-in-1 Dimmable
- 0-100% Dimming
- Waterproof IP67

**Size:**  
**8"x3.5"x1.5"**

# LED DRIVER OUTPUT 24V



ITEM NO.	INPUT	OUTPUT	SIZE	IP RATING
WP 2601	AC 100-130V	DC24V Max 100W	5.8"x2"x1"	IP 20
WP 2602	AC 100-130V	DC24V Max 200W	8.6"x2"x1"	IP 20
WP 2603	AC 100-130V	DC24V Max 300W	9.5"x2"x1.2"	IP 20

# TRANSFORMERS OUTPUT 12V

## 24W

*Item # WS 0140*



- Input: AC100-240V
- Output: DC 12V 2A

## 60W

*Item # WS 0141*



- Input: AC100-240V
- Output: DC 12V 5A

## 60W IP20

*Item # WS 60WIP20*



- Input: AC100-240V
- Output: DC 12V 5A

## 60W IP65

*Item # WS 60WIP65*



- Input: AC100-240V
- Output: DC 12V 5A

## 96W

*Item # WS 0142*



- Input: AC100-240V
- Output: DC 12V 8A

# TRANSFORMERS OUTPUT 12V

## 150W IP20

*Item # WS 150WIP20*



- Input: AC 110-260V
- Output: DC 12V 12.5A

## 150W IP65

*Item # WS 150WIP65*



- Input: AC 110-260V
- Output: DC 12V 12.5A

## 250W IP20

*Item # WS 0143*



- Input: AC 110-260V
- Output: DC 12V 20A

## 250W IP65

*Item # WS 250WIP65*



- Input: AC 110-260V
- Output: DC 12V 20A

## 350W IP20

*Item # WS 0144*



- Input: AC 110-220V
- Output: DC 12V 29A

# 12V H (HIGH LEVEL) – RGB STRIP LIGHT



## NON-WATERPROOF

*Item # WS0010*

- 4 Pin Male / Female
- 4 Pin / 1 Meter & 4 Pin / 5 Meter
- Use 150pcs 5050LED Chip / Roll
- 16.40 ft. / Roll, DC 12v, 36 W / Roll
- Best Quality Use: LED Chips, Circuit Board & Components

## WATERPROOF

*Item # WS0011*

### Parts Included



- 25 pcs of clip
- 2 pcs of black rubber cover
- 5 pcs of pin

## 12V M (MIDDLE LEVEL) – RGB STRIP LIGHT



M-GRB **300pcs** 5050chip  
4 Pin (Male & Female)

**Waterproof**

**Item # WS0042**

✓ **16.4feet / Roll**

✓ **12 v Dc**

✓ **72 w / Roll**

✓ **4Pin(male,female)/**

**Roll**

# CONTROLLERS & AMPLIFIERS For 12V RGB

## Item # WS0169

### *44 Keys New Plastic GRB IR Controller*



- ✓Power: 72 W
- ✓Input: 12 V Output: 6 A

## Item # WS0165

### *New Mini RGB RF Controller*



- ✓Power: 144 W ( Can control 1 Roll only ! )
- ✓Input: 5-24V / Output:12 V
- ✓22 Dynamic mode, 20 Static color

## Item # WS0161

### *New Aluminum RGB RF Controller*



- ✓Power: 144 W
- ✓Input: 12-24V / Output: Current:12V
- ✓With Dimmer Function

## Item # WS0171 *Aluminum Amplifier*



- ✓Power: 144 W
- ✓Input / Output: 12V

## Item # WS0170 *Mini Amplifier*



- ✓Power: 144 W(1 Roll only)
- ✓Input / Output: 5-24V

# CONTROLLERS FOR 12V RGB

## 12V RGB 360W RF CONTROLLER

**Item # WS 0166**



- **Supply Voltage:** DC5V/12V/24V
- **Remote Control Distance:** 20m
- **Power Output:** 5V/120W, **12V/360W** , 24V/576W

## 12V RGB 360W RF CONTROLLER

**Item # WC 0001 w/ Touch Remote**

**Item # WC 0002 w/o Remote**



Supply voltage	DC5V, 12V~24V optional (specify the required voltage on orders)
Output current	<8A(each channel)
Output power	5V:<120W, <b>12V:&lt;360W</b> , 24V:<576W

## Wire Instruction for Job for Both Controller

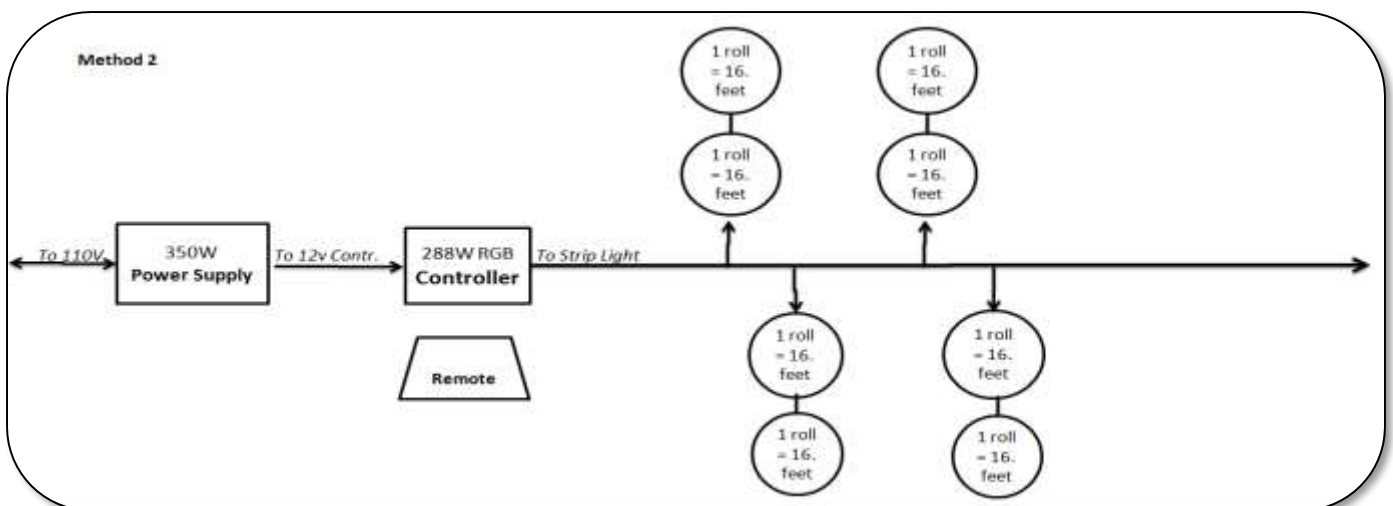

# ACCESSORIES FOR RGB STRIP

## Directly Connect These Accessories To The Rolls

Item # WS0096

**N4 T Connector**



❖ Use for single & RGB

Item # WS0097

**N4 L Connector**



❖ Use for single & RGB

Item # WS0098

**N4 Cross Connector**



❖ Use for single & RGB

Item # WS0099

**N4 Middle Connector**



❖ Use for single & RGB

Item # WS0120

**Cross Connector 4 Pin**



❖ Use for single & RGB

Item # WS0121

**12" Wire Connector 4 Pin**



❖ Use for single & RGB

Item # WS0122

**12" Cable Connector 4 Pin**



❖ Male & Female

❖ Use for RGB strip

Item # WS0123

**24" Cable Connector 4 Pin**



❖ Male & Female

❖ Use for RGB strip

## Accessories To Use After Custom Cuts Are Made

Item # WS0124

**M4-Connect Box**



❖ Middle Connector

❖ 4 clip

Item # WS0126

**M4-Connector 6"**

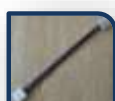

❖ 4 clip

Item # WS 0130

**T Connector**

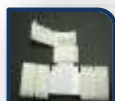

Item # WS0125

**H4-Connector 6"**

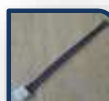

❖ Head Connector

❖ 4 clip & 4 wire

Item # WS 0129

**L Connector**

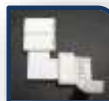

Item # WS 0131

**Cross Connector**



## Other Accessories

Item # WS0133

**4 Wire Line**



Sell by feet

❖ 1 Meter long

❖ Clear Plastic

# 12V H (High Level)- Single Color Strip



APPROVED



**2700K**

**3000K**

**3500K**

**4500K**

**5500K**

Item # WS0024

WS0020

WS0021

WS0022

WS0023

**\* 12V \* 36W/Roll \* waterproof \* 4 pin Male/Female \***

## ***Parts Included***



- **15" connector 1 pc**
- **20 pcs of clip**
- **2 pcs of black rubber cover**

# 12V - COB STRIP LIGHT

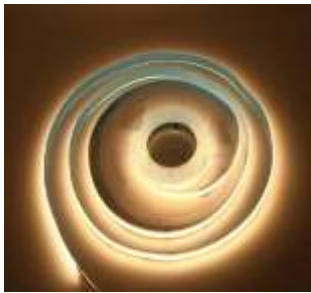

**3000K**



**6000K**

**Item # WS0083**

- ✓ 16.4feet / Roll
- ✓ 12 v Dc
- ✓ PCB (MM)\_8MM
- ✓ 336LED/ M
- ✓ 16W / M
- ✓ 1400LM / M

**Item # WS0084**

- ✓ 16.4feet / Roll
- ✓ 12 v Dc
- ✓ PCB (MM)\_8MM
- ✓ 336LED/ M
- ✓ 16W / M
- ✓ 1400LM / M



**Item # WS 9083**

**Middle Connect**

# ***MEDIUM BRIGHT 12V 8MM***

**Random Cutting, Max Run 16.4 Ft.**

**NEW**



<b>Item No.</b>	<b>Color Temp</b>
<b>WS 0085</b>	<b>2700K</b>
<b>WS 0086</b>	<b>3000K</b>
<b>WS 0087</b>	<b>5500K</b>

<b>Description</b>	<b>Details</b>
<b>Length Per Pack</b>	<b>100 Feet Per Reel</b>
<b>Cut Internal</b>	<b>Anywhere</b>
<b>Voltage</b>	<b>12V DC</b>
<b>Max Run</b>	<b>16.4 Feet</b>
<b>Rating</b>	<b>IP 20</b>
<b>Watts Per Ft.</b>	<b>2.44 W/ Ft.</b>
<b>Efficiency</b>	<b>91 Lm. / W</b>
<b>Lumens Per Ft.</b>	<b>202/ 205/ 208</b>
<b>CRI</b>	<b>&gt;85</b>
<b>Warranty</b>	<b>2 Years</b>

# ***MEDIUM BRIGHT 24V 8MM***



**Constant Current , Max Run 66 Ft.**

**NEW**



<b>ITEM NO.</b>	<b>Color Temp</b>
<b>WS 0827</b>	<b>2700K</b>
<b>WS 0830</b>	<b>3000K</b>
<b>WS 0855</b>	<b>5500K</b>

<b>Description</b>	<b>Details</b>
<b>Length Per Pack</b>	<b>66 Feet Per Reel</b>
<b>Cut Internals</b>	<b>1.9 ” Per cut</b>
<b>Voltage</b>	<b>24V DC</b>
<b>Max Run</b>	<b>66 Feet</b>
<b>Rating</b>	<b>IP 20</b>
<b>Watts Per Ft.</b>	<b>2.29 W/ Ft.</b>
<b>Efficiency</b>	<b>91 Lm./ W</b>
<b>Lumens Per Ft.</b>	<b>202 / 205 / 208</b>
<b>CRI</b>	<b>&gt;90</b>
<b>Warranty</b>	<b>5 Years</b>

# ***SUPER BRIGHT 24V 10MM***



**Max Run 32.8 Ft.**

**NEW**

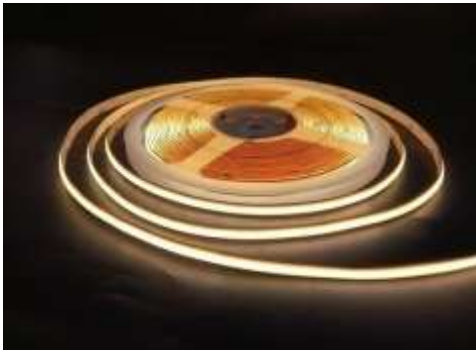

<b>ITEM NO.</b>	<b>Color Temp</b>
<b>WS 1027</b>	<b>2700K</b>
<b>WS 1030</b>	<b>3000K</b>
<b>WS 1055</b>	<b>5500K</b>

<b>Description</b>	<b>Details</b>
<b>Length Per Pack</b>	<b>100 Feet Per Reel</b>
<b>Cut Internals</b>	<b>1.9 " per cut</b>
<b>Voltage</b>	<b>24V DC</b>
<b>Max Run</b>	<b>32.8 Feet</b>
<b>Rating</b>	<b>IP 20</b>
<b>Watts Per Foot</b>	<b>4.42 W/FT.</b>
<b>Efficiency</b>	<b>140 LM./W</b>
<b>Lumens</b>	<b>561/596/619</b>
<b>CRI</b>	<b>&gt;90</b>
<b>Warranty</b>	<b>5 Years</b>

# ACCESSORIES FOR COB 12/24V

**NEW**

## L/T CONNCTOR FOR 8MM & 10MM

Item No. WS9086



Item No. WS9106



## MIDDLE CONNETOR FOR 8MM & 10MM COB 12V/24V

Item No. WS9083



Item No. WS9103



## 6" POWER CONNETOR FOR 8MM & 10mm COB 12V/24V

Item No. WS9084



Item No. WS9104



## 6" JUMP CONNETOR FOR 8 MM &10MM COB 12V/24V

Item No. WS9085



Item No. WS9105



# 12V M (MIDDLE LEVEL) - Single Color 300 /Roll



- 300 pcs 5050 LED chip/roll
- 12V
- 16.4Ft./Roll
- DC head male/female
- 48 W /Roll

<p><b><u>3000K</u></b>  <i>use 300 pcs 5050 LED chip/ roll</i></p>	<p>None  <b>Waterproof</b>  <b>Item# WS 0043</b></p>	<p><b>Waterproof</b>  <b>Item# WS 0043W</b></p>
<p><b><u>5500K</u></b>  <i>use 300 pcs 5050 LED chip/ roll</i></p>	<p>None  <b>Waterproof</b>  <b>Item# WS 0044</b></p>	
<p><b><u>Green</u></b>  <i>use 300 pcs 5050 LED chip/ roll</i></p>		<p><b>Waterproof</b>  <b>Item# WS 0065</b></p>
<p><b><u>Blue</u></b>  <i>use 300 pcs 5050 LED chip/ roll</i></p>		<p><b>Waterproof</b>  <b>Item# WS 0066</b></p>
<p><b><u>Red</u></b>  <i>use 300 pcs 5050 LED chip/ roll</i></p>		<p><b>Waterproof</b>  <b>Item# WS 0067</b></p>
<p><b><u>Yellow</u></b>  <i>use 300 pcs 5050 LED chip/ roll</i></p>		<p><b>Non Waterproof</b>  <b>Item# WS 0068</b></p>

Item # WS0116  
N2 T Connector



Item # WS0117  
N2 L Connector



Item # WS0118  
N2 Cross Connector



Item # WS0109  
N2 Connector 6"



Item # WS0119  
N2 Connect Box



Accessories' details on P. 11

# LED MODULE LIGHT, WATER PROOF , 12V



Item no: **WS 0070**  
Color temp : **RGB** , High Brightness. 5050 LED Chips  
Lumens : 120 Lumens / 3LED Chanel  
Power : 0.72w/ 3LED Chanel  
Length : 5 inch ( Each Module :including wire )



Item no: **WS 0075**  
Color temp : **6000-6500k**, High Brightness. 5730 LED Chips  
Lumens : 165 Lumens / 3LED Chanel  
Power : 1.44w / 3LED Chanel  
Length : 5 inch ( Each Module :including wire )



Item no: **WS 0071**  
Color temp : **3000-3500k**, High Brightness. 5730 LED Chips  
Lumens : 165 Lumens / 3LED Chanel  
Power : 1.44w / 3LED Chanel  
Length : 5 inch ( Each Module :including wire )

# DIMMER FOR SINGLE COLOR

## Item # WS0182 *Mini Dimmer w/ Remote*



- Power: 144W
- Input: DC5-24V
- Output: 12A

## Item # WS0180 *Dimmer Set*



- Power: 96W
- Input: DC12-24V
- Output: 8A

## Item # WS0181 *Dimmer for Wall w/ Remote*



- Power: 72W
- Size:L3 3/8" x W3 3/8" x H1 5/8"
- Supply: DC12-24v, Current: 6A

# ACCESSORIES FOR H-SINGLE COLOR

## Directly Connect These Accessories To The Rolls

Item # WS0121

**12" Wire Connector 4 Pin**



❖ Use for single & RGB

Item # WS0120

**Cross Connector 4 Pin**



❖ Use for single & RGB

Item # WS0096

**N4 T Connector**



❖ Use for single & RGB

Item # WS0097

**N4 L Connector**



❖ Use for single & RGB

Item # WS0098

**N4 Cross Connector**



❖ Use for single & RGB

Item # WS0099

**N4 Middle Connector**



❖ Use for single & RGB

## Accessories To Use After Custom Cuts Are Made

Item # WS0124

**M4-Connect Box**



❖ Middle Connector  
❖ 4 clip

Item # WS0125

**H4-Connector 6"**



❖ Head Connector  
❖ 4 clip & 4 wire

Item # WS0126

**M4-Connector 6"**



❖ 4 clip

Item # WS 0129

**L Connector**



Item # WS 0130

**T Connector**



Item # WS 0131

**Cross Connector**



## Other Accessories



Item # WS0127 **15" Connector**

❖ DC & 4Pin Head



Item # WS0128 **T Connector 4 Pin**

❖ DC & 4Pin Head (Male & Female)



Item # WS0133 **4 Wire Line**

Sell by feet

# ACCESSORIES FOR M-SINGLE COLOR

Use for 600 pcs LED chip

Use for 300 pcs LED chip

**Item # WS0114**     **3DC Power Feet**



❖ Use for M-Single color strip lights

**Item # WS0116**     **N2 T Connector**



❖ Middle Connector  
❖ 2 clip

**Item # WS0115**     **1DC Power Feet**

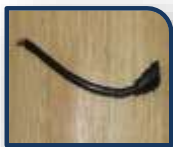

❖ Use for M-Single color strip lights

**Item # WS0117**     **N2 L Connector**



❖ Middle Connector  
❖ 2 clip

**Item # WS0110**     **M2 Connect Box**



❖ Middle Connector  
❖ 2 clip

**Item # WS0118**     **N2 Cross Connector**



❖ Middle Connector  
❖ 2 clip

**Item # WS0112**     **H2 Connector 6"**



❖ With DC Head  
❖ 2 clip & 2 wire

**Item # WS0119**     **N2 Connect Box**



❖ Middle Connector  
❖ 2 clip

**Item # WS0111**     **M2 connector 6"**



❖ 2 clip

**Item # WS0109**     **N2 Connector w/ DC**



❖ With DC Head  
❖ 2 clip

**Item # WS0108**     **N2 Connector 6"**



❖ 2 clip

# H - CHASING STRIP LIGHT



## *Waterproof*

**Item # WS0002**

- **114 Modes of Chasing Color Change**
- **Use 150pcs 5050LED Chip / Roll, 5 Pin Male/Female**
- **16.40 feet / Roll, DC 12v, 36 w / Roll**

## *Parts Included*



- **25 pcs of clip**
- **2 pcs of pin**
- **2 pcs of black rubber cover**

# H-CHASING ACCESSORIES

Item # WS0164

## *Chasing Controller*



- ❖ Effect Mode= 114 modes of chasing color change
- ❖ Input/Output: DC12v only
- ❖ Current: <60MA
- ❖ Use for **High Level Chasing Strip**

Item # WS0100

## *T Connector 5 Pin*



- ❖ Power Supply Connect
- ❖ Pin Connect
- ❖ Use for High Level Chasing

Item # WS0101

## *12" Wire Connector 5 Pin*



- ❖ Use for High Level Chasing

Item # WS0102

## *Cross Connector 5 Pin*



- ❖ Use for High Level Chasing

# Instruction for 12v RGB Strip

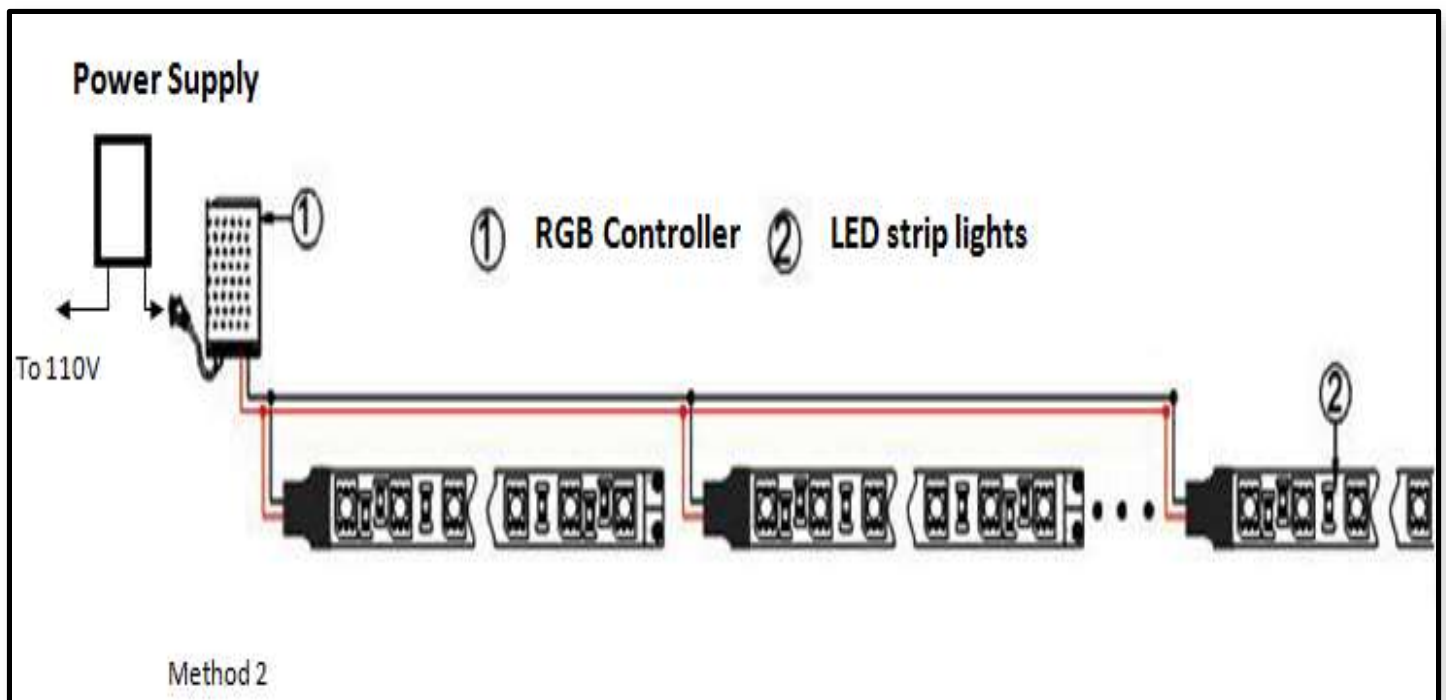
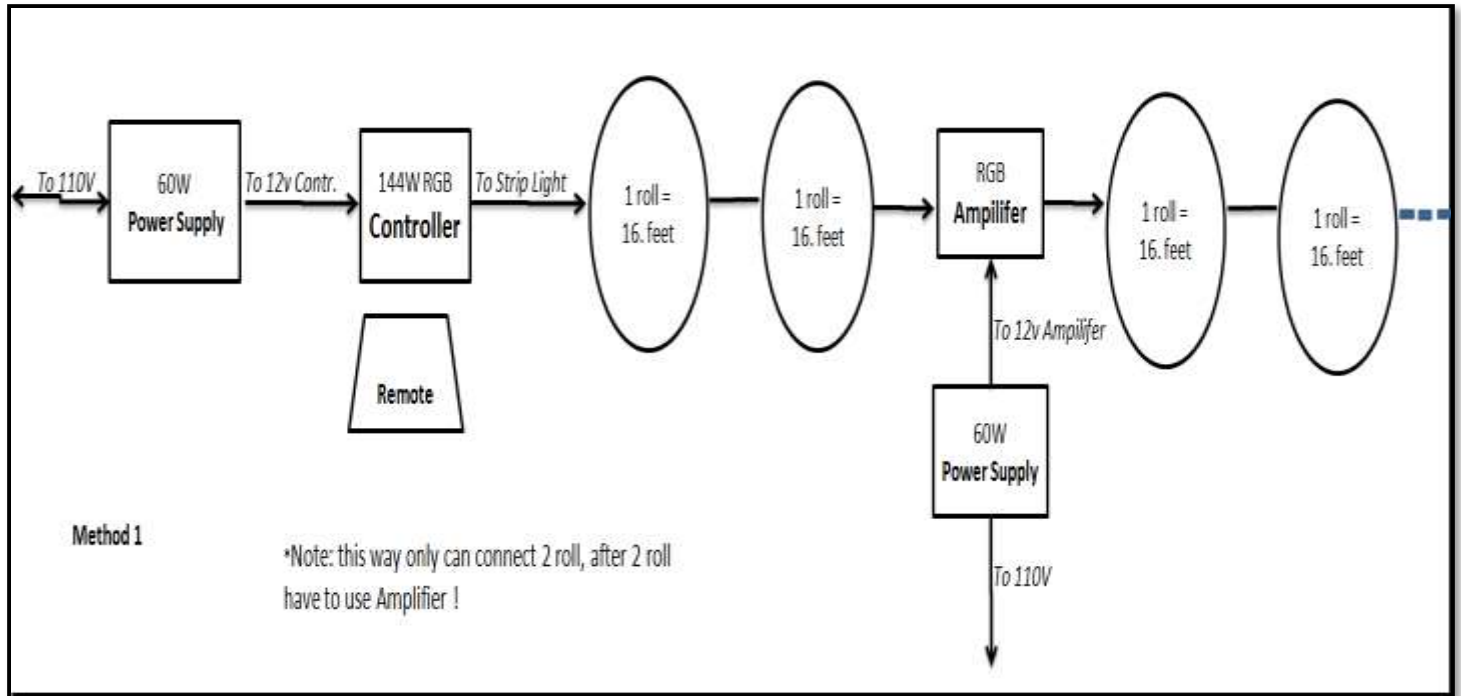

# Wire Instruction for 12V Single Color Strip

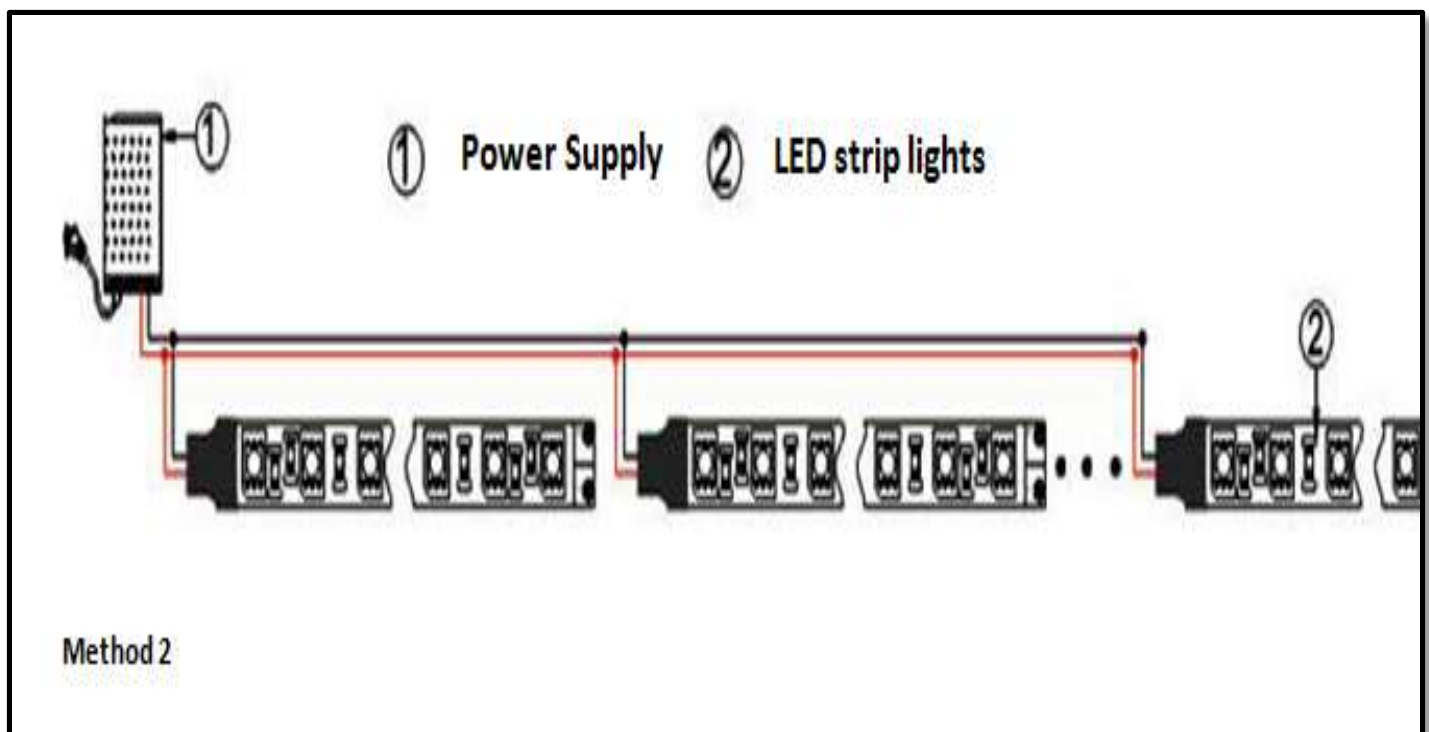
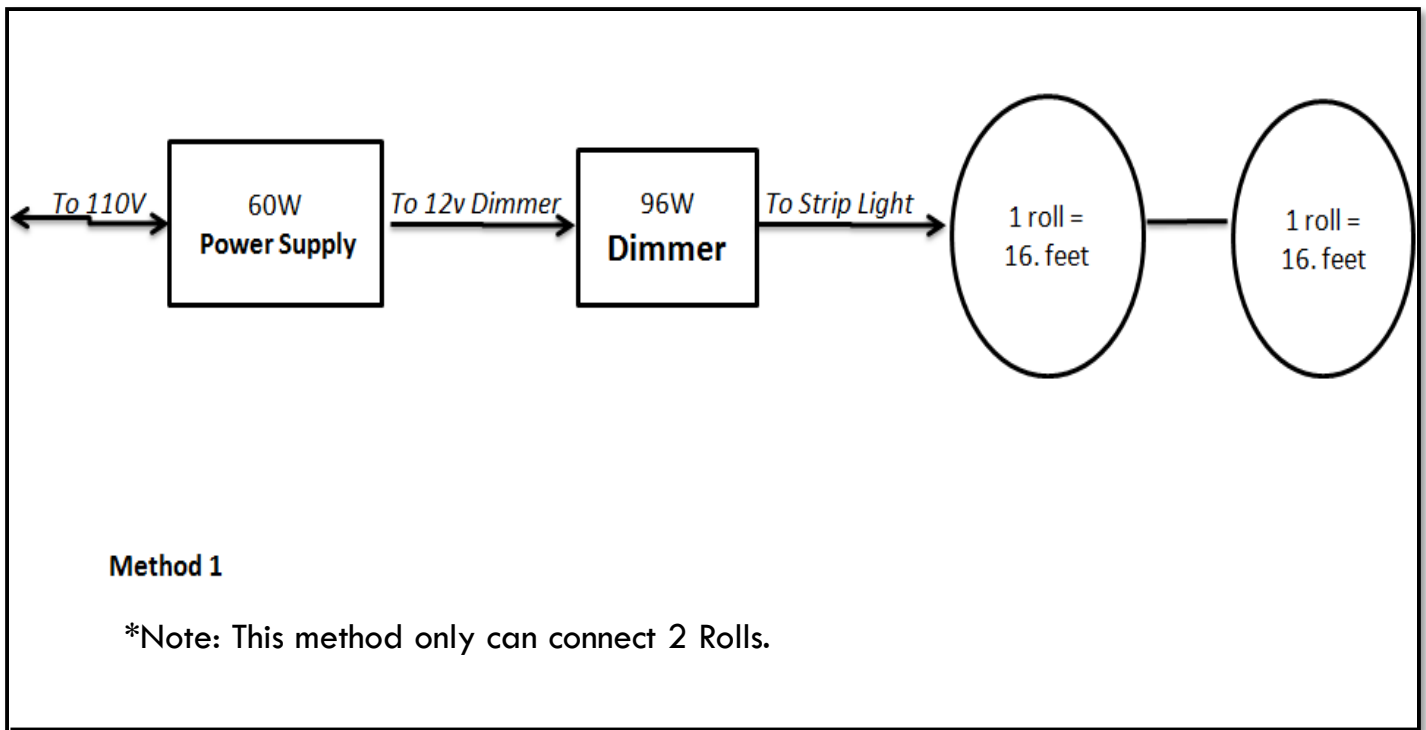

# OUTDOOR FLOOD LIGHT

## 30W (DAYLIGHT)

Item # WO 4130



- 5500K
- Power: 30W
- Voltage: AC90-260V
- Luminous Flux: >1400lm
- Beam Angle: 120 Degrees
- Color Temp: Daylight
- Dimension: 7"x5.5"x4.5"
- Material: Aluminum
- Life Span: 50,000 hrs
- IP Grade: IP65

## 50W RGB w / REMOTE

Item # WO RGB50



- LED type: COB
- Power :50W
- Dimension:11"x9"x5.5"
- Input (V): 90~260V AC
- Lumens: 0 - 3850 lm
- Material: Aluminum
- IP grade: IP65

## 100W

Item # WO 4100



- Power: 100W
- Voltage: AC90-260V
- Luminous Flux: > 110Lm/W
- Color Temp: 6000k
- Dimension: 12.5"x9.5"x2.5"
- Material: Aluminum
- IP Grade: IP65

## 200W

Item # WO 4300



- Power: 200W
- Voltage: AC85-265V
- Luminous Flux: ≥110Lm/W
- Color Temp: 6000k
- Dimension: 18.5"x12.5"x2.5"
- Material: Aluminum
- IP Grade: IP65

# LED DESK LAMP

*Item # WD 290*

**White**

**Dimmable & CCT 30-60k**



- ✓ **Power:** 12W
- ✓ **Input:** DC12V
- ✓ **Color Temperature:** CCT.3000K~6000K
- ✓ **Desk Lamp Size:** 41\*18\*20\*44cm
- ✓ **Beam Angle:** 140 degree
- ✓ **Long Lifespan:** 50,000h
- ✓ **Warranty:** 2 years
- ✓ **Dimmable:** 0-100
- ✓ **Safe To Touch**
- ✓ **No Radiation ! No Ultraviolet ! No Flash !**